



CONNECT AND PROTECT

Flexible Conductors

(North America)

Solutions to Optimize the Design of Electrical Power &
Earth/Ground Connections

nvent

ERIFLEX

TABLE OF CONTENTS

FLEXIBLE CONDUCTORS FOR VARIOUS APPLICATIONS	06
CERTIFICATES	08
PRODUCT OVERVIEW	09
NVENT ERIFLEX FLEXIBAR INSULATED FLEXIBLE BUSBAR	10
ACCESSORIES	22
HYDRAULIC AND MANUAL TOOLS FOR BUSBAR & FLEXIBAR	26
INSULATED BRAIDED CONDUCTOR (IBS, IBSB, IBSBR & IBSHY)	28
EARTH/GROUND COPPER BRAIDS (MBJ & BJ)	38
EARTH/GROUND STAINLESS STEEL BRAIDS (CPI & CPIW)	40
POWER SHUNT (PBC & PPS)	44
FLAT COPPER & STAINLESS STEEL BRAIDS IN COILS (FTCB, FRCB, FSSB & FTCBI)	46
ROUND AND TUBULAR COPPER BRAIDS IN COILS (RTCBI, RTCB, RRCB, RRCBI & TTCE)	48
MAKE YOUR OWN BRAIDED CONNECTIONS	49
MADE-TO-ORDER SOLUTIONS	50
CROSS REFERENCE LIST	52

Flexible Conductors for Low-Voltage Industries

NVENT OFFERS

- Strong worldwide expertise in different markets
- A worldwide team of experts in electrical power connections
- Global solutions manufacturing
- Complete range of high-quality, reliable, certified products
- Innovative and compatible product solutions

ENERGY

- Electrical Power Generators and Distribution
 - Transformers
 - Generators
- Renewable Energies
 - Windmills
 - Solar
 - Hydropower
- Oil, Gas and Petrochemical
- Telecom
- Power Stations



TRANSPORTATION

- Marine
- Aircraft
- Ground Transportation
- Automotive





INDUSTRY & BUILDINGS

- Air Conditioning
- Elevators, Escalators & Automatic Doors



PANELBOARD

- Power
- Control & Command Applications:
 - Power Switchboards
 - Distribution Panel
 - UPS
 - Power Factory Correction



MACHINERY

- Tunneling
- Crushers
- Printing
- Welding
- Packaging
- Woodworking



Flexible Conductors for Various Applications

nVent is well-known for producing high quality flexible conductors for low voltage power connections. Flexible conductors made out of braids or laminates are used in a variety of applications for current transfer or grounding/earthing connections.



Worldwide certifications, applications and product availability

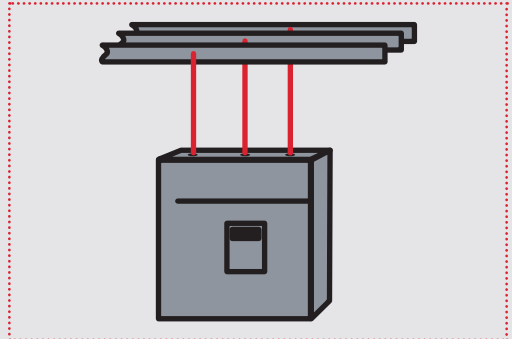

Busbar and active electrical component connections (Example: circuit breaker, contactor) including most compact components on the market

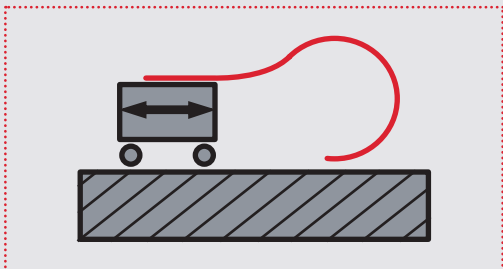

Flexible connections between fixed and moving parts

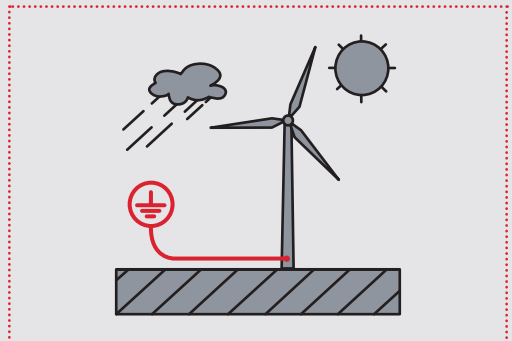

Outdoor/offshore applications or difficult environments (Example: abrasion, corrosion, UV...)

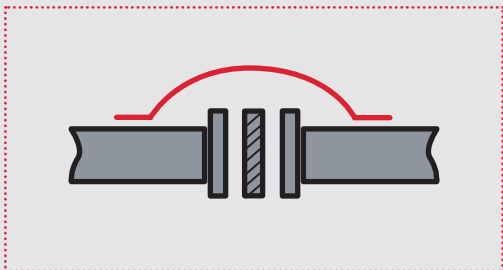

Earthing/grounding interconnections (Example: pipeline)

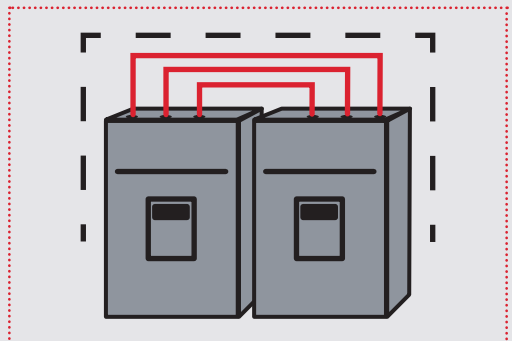

Short and compact connections between electrical components for volume reduction

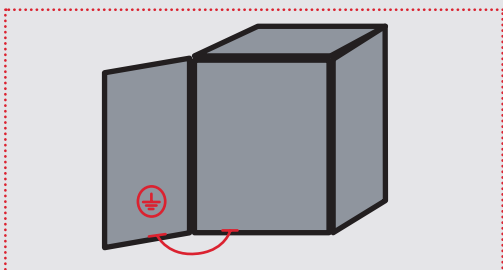

Earthing/grounding connections with excellent electro-magnetic compatibility

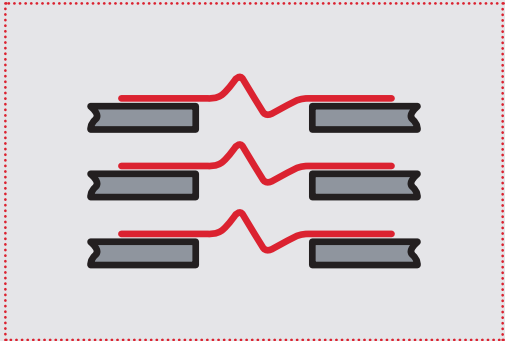

Expansion connections for busbar systems

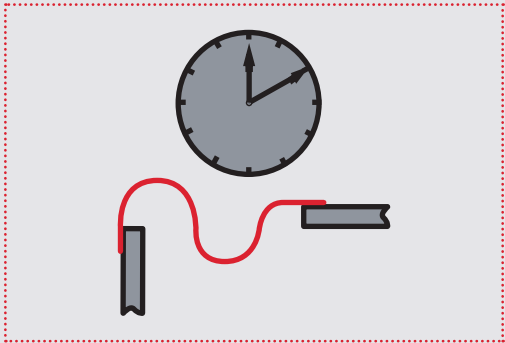

Reduce time assembly or maintenance connections

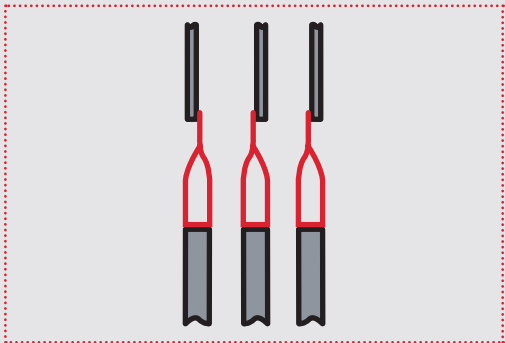

Power connections between horizontal and vertical system

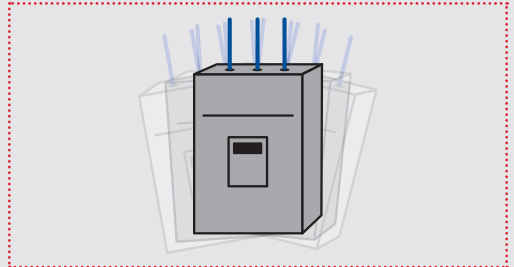

Vibration and reliability solution for connections

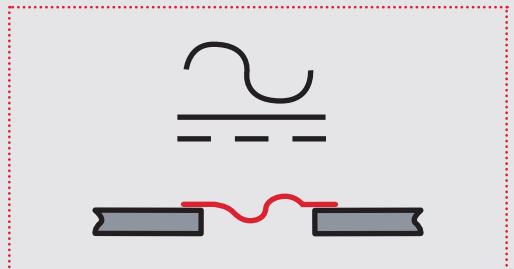

Connections for alternating current or direct current application

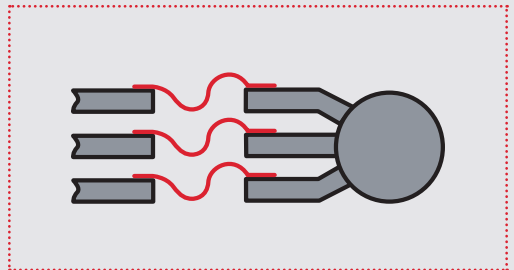

Motor, generator or transformer connections with busbar system

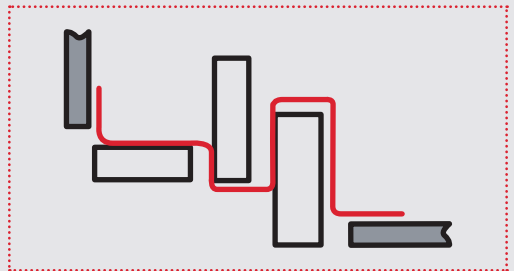

Connections everywhere

Certificates

TESTS & CERTIFICATES

nVent ERIFLEX components are compliant with several agencies and standards to meet all requirements

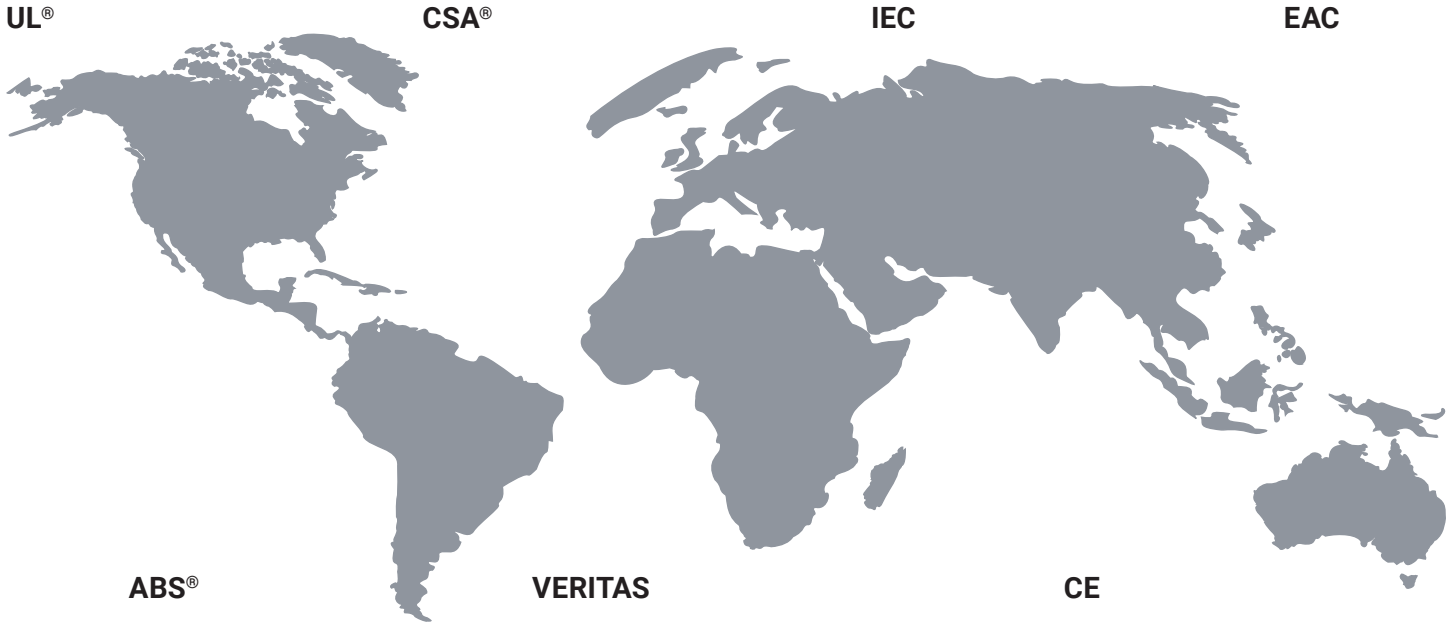

International Electrotechnical Commission
IEC 60439.1 Standard
IEC 61439.1 Standard



European Conformity



Underwriters Laboratories
UL Recognized. File No. E125470
UL Recognized. File No. E220029
UL Recognized. File No. E316390



Bureau VERITAS
Certificate No. 02859 / DO BV for shipboard use



UL Listed. File No. E220029



EAC Certificate compliance for Russia



Canadian Standards Association
CSA Certified. File No. LL 90005
CSA Certified. File No 700 443 70



RoHS Compliant



ABS American Bureau of Shipping
Certificate No. 08-HS365878-1-PDA-DUP &
Certificate No. 13-HS1018106-1-PDA-DUP
Marine & Offshore Applications



Halogen-free materials

Product Overview

Product Range	Typical Uses	Typical Market
Flexibar: Advanced, Standard, Summum 	<ul style="list-style-type: none"> • Heavy-duty power interconnection • Overcome vibration/alignment problems • Circuit breaker, generator & prefabricated power network conductor • Expansion joints • Variable terminating positions • Machine connections • Movable connection from massive busbar system • Alternative to large & multiple cables • Alternative to rigid busbar 	<ul style="list-style-type: none"> • Switchgear & control equipment • Transportation • Electrical equipment manufacturers • Power generation • Machinery manufacturing
Insulated braided conductor (IBS, IBSB, IBSBR & IBSHY) 	<ul style="list-style-type: none"> • Interconnects for low voltage power distribution units • IBSB specially designed for industrial circuit breaker connection • Overcome vibration/alignment problems • Battery connections • Earth/ground connections 	<ul style="list-style-type: none"> • Switchgear & control equipment • Transportation • Electrical equipment manufacturers • Power generation
Power shunt (PBC & PPS) 	<ul style="list-style-type: none"> • Transformer or generator to busbar connection • Overcome vibration/alignment problems • Power interconnection 	<ul style="list-style-type: none"> • Switchgear & control equipment • Power distribution • Transportation
Earth/ground copper braids (MBJ & BJ) 	<ul style="list-style-type: none"> • Power, earthing/grounding and equipotential connections • Electrical bonding enclosure door • EMI effect reduction application 	<ul style="list-style-type: none"> • Switchgear & control equipment • Rail transportation • Electrical equipment manufacturers • Power generation (wind, solar) • Data center
Earth/ground stainless steel braids (CPI & CPIW) 	<ul style="list-style-type: none"> • Earthing/grounding and equipotential connections • Superior abrasion, corrosion, chemical, and UV resistance for outdoor applications • Expansion joints • Connections for lightning protection systems 	<ul style="list-style-type: none"> • Transportation • Food and beverage industry • Power generation (wind, solar) • Chemical and oil industry • Automotive • Defense & aerospace • Civil construction • Urban projects
Flat and round copper braids in coils 	<ul style="list-style-type: none"> • Earth/ground connections • Power interconnection • Lightning protection • Flexible links • Overcome vibration/alignment problems 	<ul style="list-style-type: none"> • Defense & aerospace • Rail transportation • Automotive • Electronics • General electrical sector • Civil construction
Tubular copper braids in coils 	<ul style="list-style-type: none"> • Screening of cables from electromagnetic, electrostatic and RF interference • Mechanical support • Protection against abrasion and corrosion • EMC & EMH applications 	<ul style="list-style-type: none"> • Defense & aerospace • Transportation • Electronics & communication • Cable harness & assembly makers • Component distributors

Insulated Flexible Busbar

A COMPLETE RANGE FLEXIBLE BUSBAR

- ADVANCED
- STANDARD
- SUMMUM



ENHANCED FLEXIBILITY

nVent's exclusive manufacturing process offers superior flexibility:

- Copper laminates are free to slide within the insulation
- High insulation quality
- Wide variety of bending, twisting & folding possibilities

INNOVATIVE PATENT INSULATION

Flexibar has added grooves on the inner surface of the insulation sleeve to improve sliding between the central conductor and the insulation material. The grooves help to reduce the contact surface between the central conductor and the insulation material. This results enhances the flexibility of the flexible busbar.

Result: <20% of the inner surface is in contact with the central conductor.

This nVent ERIFLEX patent idea makes Flexibar more flexible than ever and allows users to optimize the design of their electrical power connection.

* This patent is applicable for the cross section indication by "*" on the part number.

THE REFERENCE CONDUCTOR

- nVent ERIFLEX Flexibar is composed of multiple layers of thin electrolytic copper, available in plain (Standard and Summum) or tin plated (Advanced & Standard)
- Flexibar connections are made by punching directly through the laminates. There are no lugs to purchase, which eliminates faulty connection problems and makes installation easier and faster
- The insulation is a high-resistance, self-extinguishing TPE (Flexibar Advanced), Silicone (Flexibar Summum) or PVC (Flexibar Standard) compound
- Traceability code and designation Part Number on product
- Easily formed, Flexibar improves assembly flexibility and aesthetics of panels
- Optimal alternative to large cable & rigid busbar
- Quality: 100% production dielectric tested
- Full range from 24 mm² up to 1200 mm²



FEATURES

- Self-extinguishable/flame retardant
- High mechanical resistance
- High elongation value
- High current withstanding
- High copper quality (99.9% purity)
- High conductivity

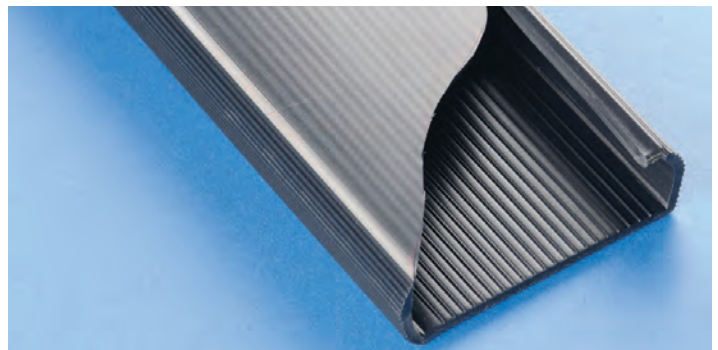

CONNECTION TYPES

- Between main power and distribution equipment (contactors, circuit-breakers...)
- Between transformer and busduct
- Between busduct and electrical cabinet

SPACE/WEIGHT SAVINGS

- Less installation space compared to cable
- Reduces the length, number of conductors and weight
- Insulation allows for closer spacing than traditional busbar designs

COST SAVINGS

- Eliminates cost and installation of lugs
- Reduces inventory costs

IMPROVES RELIABILITY

- ERIFLEX Flexibar is directly connected thus eliminating the cable lug connection
- Excellent resistance to vibration
- No crimping

AESTHETICS

- Optimal flexibility for easy access

EASY INSTALLATION

- Thanks to its design Flexibar can be easily bent and shaped for all sizes

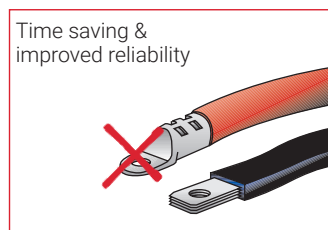
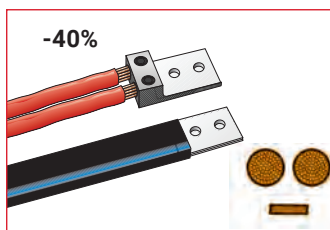
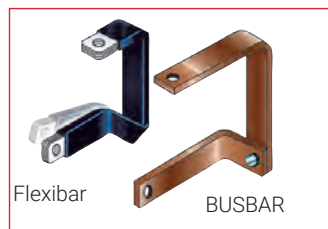
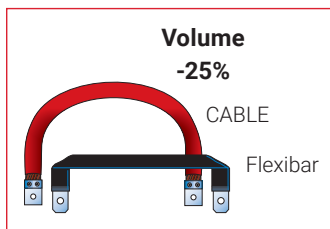

SKIN EFFECT ON A.C. APPLICATION

COPPER CABLE

FLEXIBAR

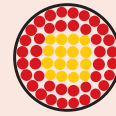

OR



150 AMPS
1/0
5.35 sq. mm
(.373 In)

158 AMPS
3 x 9 x 0.8 mm
21.6 sq. mm
60% smaller

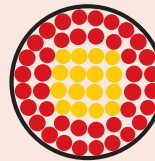

OR



380 AMPS
500 MCM
253 sq. mm
(.813 In)

379 AMPS
3 x 24 x 1 mm
72 sq. mm
71% smaller

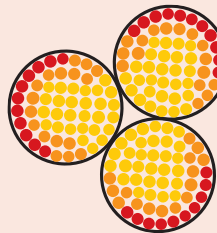
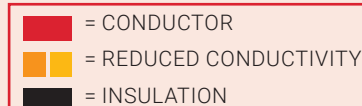

OR



1140 AMPS
(3) 500 MCM
759 sq. mm
(.813 In)

1211 AMPS
4 x 80 x 1 mm
320 sq. mm
58% smaller

Representative to scale.
Flexibar ampacity and cable ampacity are based on (NEC Table 310-16, 75° column) conductor temperature rise of 45°C.

Flexibar Advanced

UNIQUE - SAFER - FLEXIBLE



Flexibar Advanced Unique – Safer – Flexible

- Conductor is electrolytic **tinned** copper (Cu-ETP)
- Insulation is a high-resistance TEP **Low Smoke. Halogen Free and Flame Retardant (LSHFRR)** compound:
 - Typical elongation: 500%
 - Working temperature: -50°C,+115°C
 - Typical thickness: 1.8 mm
 - Self-extinguishing: UL 94 V0
 - Dielectric strength: 20kV/mm
 - Nominal voltage: 1000 V AC/1500 V DC (IEC – UL)
 - Dielectric strength: 20kV/mm

WHY IS FLEXIBAR ADVANCED A SAFER INSULATION?

Low smoke features:

- Generates less corrosive smoke ISO 5659-2
- Improves visibility for people to be able to easily locate the emergency exit and also allows rescue workers to better assess an emergency situation

The halogen-free feature enables:

- Reduction in the quantity of toxic smoke
- Minimum of toxicity with no halogens (according to IEC 60754-1)
- Use in enclosed spaces for specific applications such as submarines, switchboards, and other enclosed environments that require a low emissions solution

The flame retardant portion of the test illustrates the self-extinguish feature:

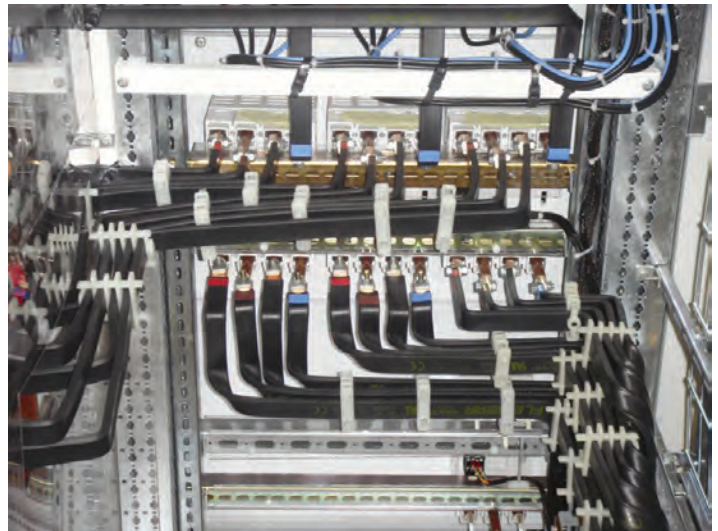

- Compliant with the UL 94-V0 Glow wire test @ 960°C (IEC 60695-2) testing standard
- Reduces the risk of the spread of fire
- Less damage to your electrical installation

Flexibar Advanced has a unique insulation on the market that combines **low smoke, halogen-free and flame retardant** features that improve both the reliability of your electrical installation and safety for equipment and people.

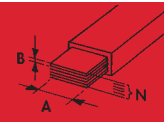

Some photographs in the Flexibar Advanced section may actually be using Flexibar

FLEXIBAR ADVANCED TECHNICAL CHARACTERISTICS

Typical Application Current Rating	Part Number				Section mm ²	ΔT 20°C (A)	ΔT 30°C (A)	ΔT 35°C (A)	ΔT 40°C (A)	ΔT 45°C (A)	ΔT 50°C (A)	ΔT 60°C (A)	ΔT 65°C (A)	ΔT 70°C (A)	Current Coefficient	
						N	A	B	NEC® 310-16 60°C	NEC® 310-16 75°C	NEC® 310-16 90°C					
125 A	534001	3	9	0.8	21.6	101	126	138	148	158	167	185	193	201	1.72	2.25
	534004	3	13	0.5	19.5	102	128	139	150	160	169	187	195	203	1.72	2.25
	534006	2	15.5	0.8	24.8	121	152	166	178	190	201	222	232	241	1.72	2.25
	534005	6	13	0.5	39	150	188	205	221	235	249	275	287	299	1.72	2.25
	534002	6	9	0.8	43.2	153	192	210	226	241	255	281	293	305	1.72	2.25
250 A	534010	2	20	1	40	168	211	229	247	263	279	307	321	334	1.72	2.25
	534007	4	15.5	0.8	49.6	178	223	243	262	279	295	326	340	354	1.72	2.25
	534016	2	24	1	48	195	244	266	286	305	323	357	373	388	1.72	2.25
	534011	3	20	1	60	210	263	286	308	328	347	383	400	416	1.72	2.25
	534008	6	15.5	0.8	74.4	225	282	308	331	353	374	412	430	448	1.72	2.25
	534017	3	24	1	72	243	304	331	356	379	402	443	463	482	1.72	2.25
	534012	4	20	1	80	246	308	336	361	385	408	450	470	489	1.72	2.25
	534023	2	32	1	64	248	311	338	364	388	411	454	474	493	1.72	2.25
400 A	534013	5	20	1	100	280	351	382	411	438	464	512	535	556	1.72	2.25
	534018	4	24	1	96	285	356	388	418	445	472	520	543	565	1.72	2.25
	534030	2	40	1	80	301	376	409	440	470	497	549	573	596	1.72	2.25
	534024	3	32	1	96	308	385	419	451	481	510	562	587	611	1.72	2.25
	534014	6	20	1	120	311	390	424	457	487	516	569	594	618	1.72	2.25
	534019	5	24	1	120	322	403	439	472	504	534	589	615	640	1.72	2.25
	534020	6	24	1	144	357	448	487	524	559	592	653	682	710	1.72	2.25
	534025	4	32	1	128	359	449	489	526	561	594	655	684	712	1.72	2.25
	534031	3	40	1	120	371	464	505	544	580	614	677	707	736	1.72	2.25
	534026	5	32	1	160	405	507	552	594	633	671	740	773	804	1.72	2.25
	534015	10	20	1	200	425	532	580	624	661	704	777	811	844	1.72	2.25
	534021	8	24	1	192	424	531	578	622	663	702	775	809	841	1.72	2.25
	534032	4	40	1	160	432	541	589	633	675	715	789	824	857	1.72	2.25
	534027	6	32	1	192	448	561	611	657	701	742	819	855	889	1.72	2.25
	534037	3	50	1	150	449	562	612	658	702	743	820	856	891	1.72	2.25
534022	10	24	1	240	484	606	660	710	757	802	885	924	961	1.72	2.25	
534033	5	40	1	200	486	608	662	712	759	804	887	926	964	1.72	2.25	
800 A	534038	4	50	1	200	521	651	709	763	813	861	950	992	1032	1.72	2.25
	534028	8	32	1	256	525	657	715	770	821	869	959	1001	1042	1.72	2.25
	534034	6	40	1	240	535	669	728	784	835	885	976	1019	1061	1.72	2.25
	534039	5	50	1	250	583	730	794	855	911	965	1065	1112	1157	1.72	2.25
	534029	10	32	1	320	595	745	811	873	931	986	1088	1136	1182	1.72	2.25
	534035	8	40	1	320	628	786	855	920	981	1039	1146	1197	1246	1.72	2.25
	534044	4	63	1	252	633	792	861	927	988	1046	1155	1205	1255	1.65	2.12
	534040	6	50	1	300	641	802	873	940	1002	1061	1171	1222	1272	1.72	2.25
	534036	10	40	1	400	702	879	956	1029	1097	1162	1282	1338	1393	1.72	2.25
	534045	5	63	1	315	706	883	961	1033	1102	1167	1288	1344	1399	1.65	2.12
534041	8	50	1	400	741	927	1009	1085	1157	1226	1352	1412	1469	1.72	2.25	
1200 A	534046	6	63	1	378	772	966	1051	1130	1205	1276	1408	1470	1530	1.65	2.12
	534049	4	80	1	320	776	970	1056	1136	1211	1282	1415	1477	1538	1.65	2.12
	534042	10	50	1	500	831	1040	1132	1217	1298	1375	1517	1584	1648	1.72	2.25
	534050	5	80	1	400	861	1077	1172	1260	1344	1423	1570	1640	1706	1.65	2.12
	534047	8	63	1	504	886	1108	1205	1297	1383	1464	1616	1687	1756	1.65	2.12
	534051	6	80	1	480	938	1172	1275	1372	1463	1549	1709	1785	1858	1.65	2.12
	534048	10	63	1	630	985	1232	1341	1442	1538	1628	1797	1876	1953	1.65	2.12
	534055	5	100	1	500	1041	1301	1416	1523	1624	1719	1898	1982	2062	1.6	2.02
1600 A	534052	8	80	1	640	1073	1341	1460	1570	1674	1773	1956	2043	2126	1.65	2.12
	534056	6	100	1	600	1132	1414	1539	1655	1765	1869	2062	2153	2241	1.6	2.02
	534053	10	80	1	800	1187	1484	1614	1736	1851	1960	2164	2259	2351	1.65	2.12
	534057	8	100	1	800	1279	1598	1739	1870	1994	2111	2330	2433	2532	1.6	2.02
2000 A	534058	10	100	1	1000	1413	1765	1921	2066	2203	2332	2574	2688	2797	1.6	2.02
	534059	12	100	1	1200	1537	1920	2089	2247	2396	2537	2800	2924	3043	1.6	2.02
	534060	10	120	1	1200	1640	2049	2229	2397	2555	2706	2987	3119	3246	1.6	2.02

ADMISSIBLE CURRENTS: This table indicates the temperature rise produced by chosen current in the given section. This calculation does not take into account the heat dissipation from the switch gear.

Flexibar Advanced

UNIQUE - SAFER - FLEXIBLE

Selection of Flexibar Advanced according to the internal temperature of the panel

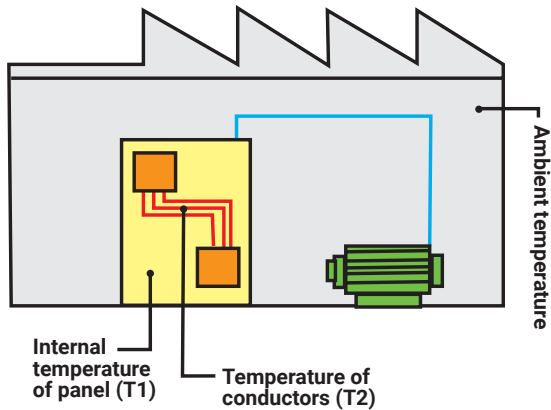

TEMPERATURE RISE OF CONDUCTOR = $T_2 - T_1 = \Delta T$ (K)

Ex: For a current of 630A, with: $T_1 = 40^\circ\text{C}$ - $T_2 = 90^\circ\text{C}$

- 1) $\Delta T = 90 - 40 = 50\text{K}$
- 2) In the 50°K column, find the closest current value to 630A. ERIFLEX Flexibar Advanced 5x32x1 - 534026 - 160 mm² - 671A.
- 3) Select ERIFLEX Flexibar Advanced according to the terminal width of the equipment being connected.

K = Kelvin degree (temperature calculated, but not measurable)

Flexibar Advanced IN PARALLEL

When using 2 or 3 Flexibar Advanced on edge in parallel for the same phase, use the coefficient:

Ex: 5 x 32 x 1 - $\Delta T^\circ = 50\text{K}$: 671A

2 bars in parallel > 671 A x 1.72 = 1154 A

3 bars in parallel > 671 A x 2.25 = 1509 A

CERTIFICATION & APPROVALS

- International Commission Electrotechnique (IEC) - Meets all requirements of IEC 61439.1
- UL 67 Recognized component in the "Panelboard and Switchboard accessories – component category (UL file E125470) for US
- UL 758 Recognized component in the "Appliance wiring material - component" category style 11681
- CE Conformity
- RoHS compliant
- Class II Conductors (IEC 61439-1. Chapter 8.4.4 - Protection by total insulation)
- Low Smoke ISO 5659-2
- Halogen-free IEC 60754-1
- Flame retardant UL94-V0
- Glow wire test @ 960°C (IEC 60695-2)



ERIFLEX Flexibar Advanced Part Numbers

2 METERS TINNED COPPER

Part Number	Global Part Number	FLEXIBAR ADVANCED Description		 Kg
534000	FADV2MTC8X6	Flexibar Advanced 2 m Tinned Copper 8X6X0.5	4	0.35
534001	FADV2MTC3X9	Flexibar Advanced 2 m Tinned Copper 3X9X0.8	4	0.43
534002	FADV2MTC6X9	Flexibar Advanced 2 m Tinned Copper 6X9X0.8	4	0.81
534003	FADV2MTC9X9	Flexibar Advanced 2 m Tinned Copper 9X9X0.8	4	1.19
534004	FADV2MTC3X13	Flexibar Advanced 2 m Tinned Copper 3X13X0.5	4	0.45
534005	FADV2MTC6X13	Flexibar Advanced 2 m Tinned Copper 6X13X0.5	4	0.79
534006	FADV2MTC2X15-5	Flexibar Advanced 2 m Tinned Copper 2X15.5X0.8	4	0.51
534007	FADV2MTC4X15-5	Flexibar Advanced 2 m Tinned Copper 4X15.5X0.8	4	1.02
534008	FADV2MTC6X15-5	Flexibar Advanced 2 m Tinned Copper 6X15.5X0.8	4	1.50
534009	FADV2MTC10X15-5	Flexibar Advanced 2 m Tinned Copper 10X15.5X0.8	4	2.20
534010	FADV2MTC2X20X1	Flexibar Advanced 2 m Tinned Copper 2X20X1	3	1.05
534011	FADV2MTC3X20X1	Flexibar Advanced 2 m Tinned Copper 3X20X1	3	1.42
534012	FADV2MTC4X20X1	Flexibar Advanced 2 m Tinned Copper 4X20X1	3	1.78
534013*	FADV2MTC5X20X1	Flexibar Advanced 2 m Tinned Copper 5X20X1	3	2.15
534014*	FADV2MTC6X20X1	Flexibar Advanced 2 m Tinned Copper 6X20X1	3	2.41
534015*	FADV2MTC10X20X1	Flexibar Advanced 2 m Tinned Copper 10X20X1	3	3.99
534016	FADV2MTC2X24X1	Flexibar Advanced 2 m Tinned Copper 2X24X1	3	1.24
534017	FADV2MTC3X24X1	Flexibar Advanced 2 m Tinned Copper 3X24X1	3	1.68
534018	FADV2MTC4X24X1	Flexibar Advanced 2 m Tinned Copper 4X24X1	3	2.12
534019*	FADV2MTC5X24X1	Flexibar Advanced 2 m Tinned Copper 5X24X1	3	2.55
534020*	FADV2MTC6X24X1	Flexibar Advanced 2 m Tinned Copper 6X24X1	3	2.99
534021*	FADV2MTC8X24X1	Flexibar Advanced 2 m Tinned Copper 8X24X1	3	3.87
534022*	FADV2MTC10X24X1	Flexibar Advanced 2 m Tinned Copper 10X24X1	3	4.75
534023	FADV2MTC2X32X1	Flexibar Advanced 2 m Tinned Copper 2X32X1	2	1.62
534024	FADV2MTC3X32X1	Flexibar Advanced 2 m Tinned Copper 3X32X1	2	2.20
534025	FADV2MTC4X32X1	Flexibar Advanced 2 m Tinned Copper 4X32X1	2	2.78
534026*	FADV2MTC5X32X1	Flexibar Advanced 2 m Tinned Copper 5X32X1	2	3.36
534027*	FADV2MTC6X32X1	Flexibar Advanced 2 m Tinned Copper 6X32X1	2	3.94
534028*	FADV2MTC8X32X1	Flexibar Advanced 2 m Tinned Copper 8X32X1	2	5.10
534029*	FADV2MTC10X32X1	Flexibar Advanced 2 m Tinned Copper 10X32X1	2	6.27
534030	FADV2MTC2X40X1	Flexibar Advanced 2 m Tinned Copper 2X40X1	2	1.99
534031	FADV2MTC3X40X1	Flexibar Advanced 2 m Tinned Copper 3X40X1	2	2.72
534032	FADV2MTC4X40X1	Flexibar Advanced 2 m Tinned Copper 4X40X1	2	3.44
534033*	FADV2MTC5X40X1	Flexibar Advanced 2 m Tinned Copper 5X40X1	2	4.16
534034*	FADV2MTC6X40X1	Flexibar Advanced 2 m Tinned Copper 6X40X1	2	4.89
534035*	FADV2MTC8X40X1	Flexibar Advanced 2 m Tinned Copper 8X40X1	2	6.33
534036*	FADV2MTC10X40X1	Flexibar Advanced 2 m Tinned Copper 10X40X1	2	7.78
534037	FADV2MTC3X50X1	Flexibar Advanced 2 m Tinned Copper 3X50X1	1	3.37
534038*	FADV2MTC4X50X1	Flexibar Advanced 2 m Tinned Copper 4X50X1	1	4.27
534039*	FADV2MTC5X50X1	Flexibar Advanced 2 m Tinned Copper 5X50X1	1	5.17
534040*	FADV2MTC6X50X1	Flexibar Advanced 2 m Tinned Copper 6X50X1	1	6.07
534041*	FADV2MTC8X50X1	Flexibar Advanced 2 m Tinned Copper 8X50X1	1	7.87
534042*	FADV2MTC10X50X1	Flexibar Advanced 2 m Tinned Copper 10X50X1	1	9.68
534044*	FADV2MTC4X63X1	Flexibar Advanced 2 m Tinned Copper 4X63X1	1	5.34
534045*	FADV2MTC5X63X1	Flexibar Advanced 2 m Tinned Copper 5X63X1	1	6.48
534046*	FADV2MTC6X63X1	Flexibar Advanced 2 m Tinned Copper 6X63X1	1	7.61
534047*	FADV2MTC8X63X1	Flexibar Advanced 2 m Tinned Copper 8X63X1	1	9.88
534048*	FADV2MTC10X63X1	Flexibar Advanced 2 m Tinned Copper 10X63X1	1	12.14
534049*	FADV2MTC4X80X1	Flexibar Advanced 2 m Tinned Copper 4X80X1	1	6.75
534050*	FADV2MTC5X80X1	Flexibar Advanced 2 m Tinned Copper 5X80X1	1	8.19
534051*	FADV2MTC6X80X1	Flexibar Advanced 2 m Tinned Copper 6X80X1	1	9.62
534052*	FADV2MTC8X80X1	Flexibar Advanced 2 m Tinned Copper 8X80X1	1	12.49
534053*	FADV2MTC10X80X1	Flexibar Advanced 2 m Tinned Copper 10X80X1	1	15.37
534055*	FADV2MTC5X100X1	Flexibar Advanced 2 m Tinned Copper 5X100X1	1	10.20
534056*	FADV2MTC6X100X1	Flexibar Advanced 2 m Tinned Copper 6X100X1	1	11.99
534057*	FADV2MTC8X100X1	Flexibar Advanced 2 m Tinned Copper 8X100X1	1	15.57
534058*	FADV2MTC10X100	Flexibar Advanced 2 m Tinned Copper 10X100X1	1	19.16
534059*	FADV2MTC12X100	Flexibar Advanced 2 m Tinned Copper 12X100X1	1	22.74
534060*	FADV2MTC10X120	Flexibar Advanced 2 m Tinned Copper 10X120X1	1	22.90

*nVent ERIFLEX Patent insulation
For other length, please contact us.

All ERIFLEX Flexibar Advanced cross sections can be bent, folded or twisted with a small bending radius for shorter and more compact power connections, from 125A up to 4500A applications.



Flexibar Standard

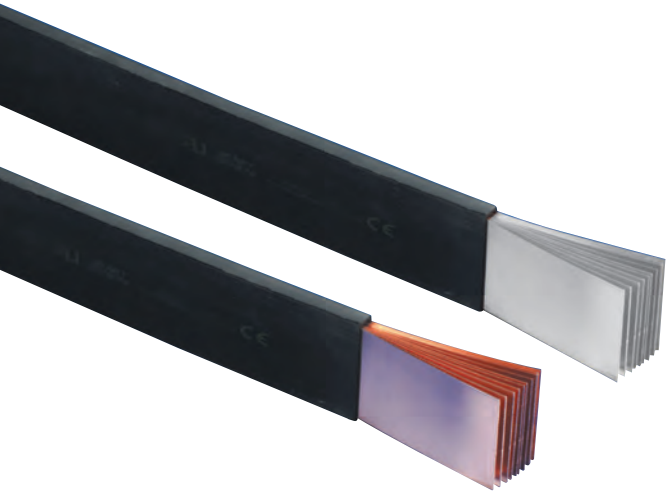

Flexibar Standard

- Conductor is electrolytic copper (Cu-ETP)
- Insulation is a high-resistance vinyl compound:
 - Elongation: 370%
 - Operating temperature: -50°C to +105°C
 - Thickness: 2 mm ± 0.2
 - Self-extinguishing: UL 94 VO
 - Dielectric strength: 20kV/mm
 - Nominal voltage = 1000 V AC/1500 V DC (UL & IEC)

Selection of Flexibar according to the internal temperature of the panel

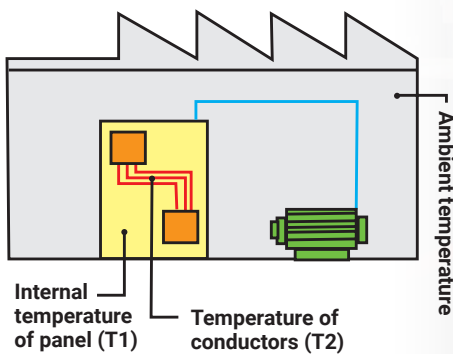

Temperature rise of conductor = $T2 - T1 = \Delta T$ (K)

Ex: For a current of 650A, with: $T1 = 45^\circ\text{C}$ - $T2 = 90^\circ\text{C}$

1) $\Delta T = 90 - 45 = 45^\circ\text{C}$

2) In the 45°C column, find the closest current value to 650A.

Flexibar 8x24x1 - 505511 -
192 mm² - 663 Amps.

3) Select Flexibar according to the terminal width of the equipment being connected.

K = Kelvin degree (temperature calculated, but not measurable)

Flexibar in parallel

When using 2 or 3 Flexibar on edge in parallel for the same phase, use the coefficient:



Ex: $5 \times 32 \times 1 - \Delta T^0 = 45 \text{ K}: 633 \text{ A}$

2 bars in parallel > $633 \text{ A} \times 1.72 = 1088 \text{ A}$

3 bars in parallel > $633 \text{ A} \times 2.25 = 1424 \text{ A}$

FLEXIBAR STANDARD TECHNICAL CHARACTERISTICS



Part Number	Length	N	A	B	UL-rated Ampacity Temp. Rise of			Description	Current Coefficient	
					30°C	45°C	60°C			
< 400 Amps @ Delta T = 45 C										
505051	2	3	9	0.8	126	158	185	Flexibar 2MTC 3x9x0.8	1.72	2.25
505053	2	3	13	0.5	128	160	187	Flexibar 2MTC 3x13x0.5	1.72	2.25
505059	2	2	15.5	0.8	152	190	222	Flexibar 2MTC 2x15.5x0.8	1.72	2.25
505054	2	6	13	0.5	188	235	275	Flexibar 2MTC 6x13x0.5	1.72	2.25
505052	2	6	9	0.8	192	241	281	Flexibar 2MTC 6x9x0.8	1.72	2.25
505501	3	2	20	1	211	263	307	Flexibar 3MTC 2x20x1	1.72	2.25
505055	2	4	15.5	0.8	223	279	326	Flexibar 2MTC 4x15.5x0.8	1.72	2.25
505506	3	2	24	1	244	305	357	Flexibar 3MTC 2x24x1	1.72	2.25
505502	3	3	20	1	263	328	383	Flexibar 3MTC 3x20x1	1.72	2.25
505056	2	6	15.5	0.8	282	353	412	Flexibar 2MTC 6x15.5x0.8	1.72	2.25
505507	3	3	24	1	304	379	443	Flexibar 3MTC 3x24x1	1.72	2.25
505503	3	4	20	1	308	385	450	Flexibar 3MTC 4x20x1	1.72	2.25
505513	3	2	32	1	311	385	454	Flexibar 3MTC 2x32x1	1.72	2.25
400 < Ampacity < 800 A @ Delta T = 45 C										
505504	3	5	20	1	351	438	512	Flexibar 3MTC 5x20x1	1.72	2.25
505508	3	4	24	1	356	445	520	Flexibar 3MTC 4x24x1	1.72	2.25
505514	3	3	32	1	385	481	562	Flexibar 3MTC 3x32x1	1.72	2.25
505505	3	6	20	1	390	487	569	Flexibar 3MTC 6x20x1	1.72	2.25
505509	3	5	24	1	403	504	589	Flexibar 3MTC 5x24x1	1.72	2.25
505510	3	6	24	1	448	559	653	Flexibar 3MTC 6x24x1	1.72	2.25
505515	3	4	32	1	449	561	665	Flexibar 3MTC 4x32x1	1.72	2.25
505521	3	3	40	1	464	580	677	Flexibar 3MTC 3x40x1	1.72	2.25
505516	3	5	32	1	507	633	740	Flexibar 3MTC 5x32x1	1.72	2.25
505511	3	8	24	1	531	663	775	Flexibar 3MTC 8x24x1	1.72	2.25
505522	3	4	40	1	541	675	789	Flexibar 3MTC 4x40x1	1.72	2.25
505517	3	6	32	1	561	701	819	Flexibar 3MTC 3x32x1	1.72	2.25
505527	3	3	50	1	562	702	820	Flexibar 3MTC 3x50x1	1.72	2.25
505512	3	10	24	1	606	757	885	Flexibar 3MTC 10x24x1	1.72	2.25
505523	3	5	40	1	608	759	887	Flexibar 3MTC 5x40x1	1.72	2.25
800 < Ampacity < 1200 A @ Delta T = 45 C										
505528	3	4	50	1	651	813	950	Flexibar 3MTC 4x50x1	1.72	2.25
505518	3	8	32	1	657	821	959	Flexibar 3MTC 8x32x1	1.72	2.25
505524	3	6	40	1	669	835	976	Flexibar 3MTC 6x40x1	1.72	2.25
505533	3	3	63	1	687	857	1002	Flexibar 3MTC 3x63x1	1.65	2.12
505529	3	5	50	1	730	911	1065	Flexibar 3MTC 5x50x1	1.72	2.25
505551	3	6	45	1	736	919	1074	Flexibar 3MTC 6x45x1	1.72	2.25
505519	3	10	32	1	745	931	1088	Flexibar 3MTC 10x32x1	1.72	2.25
505525	3	8	40	1	786	981	1146	Flexibar 3MTC 8x40x1	1.72	2.25
505534	3	4	63	1	792	988	1155	Flexibar 3MTC 4x63x1	1.65	2.12
505530	3	6	50	1	802	1002	1171	Flexibar 3MTC 6x50x1	1.72	2.25
505526	3	10	40	1	879	1097	1282	Flexibar 3MTC 10x40x1	1.72	2.25
505535	3	5	63	1	883	1102	1288	Flexibar 3MTC 5x63x1	1.65	2.12
505531	3	8	50	1	927	1157	1352	Flexibar 3MTC 8x50x1	1.72	2.25
1200 < Ampacity < 1600 A @ Delta T = 45 C										
505536	3	6	63	1	966	1205	1408	Flexibar 3MTC 6x63x1	1.65	2.12
505540	3	4	80	1	970	1211	1415	Flexibar 3MTC 4x80x1	1.65	2.12
505532	3	10	50	1	1040	1298	1517	Flexibar 3MTC 10x50x1	1.72	2.25
505541	3	5	80	1	1077	1344	1570	Flexibar 3MTC 5x80x1	1.65	2.12
505537	3	8	63	1	1108	1383	1616	Flexibar 3MTC 8x63x1	1.65	2.12
505542	3	6	80	1	1172	1463	1709	Flexibar 3MTC 6x80x1	1.65	2.12
505538	3	10	63	1	1232	1538	1797	Flexibar 3MTC 10x63x1	1.65	2.12
1600 < Ampacity < 2000 A @ Delta T = 45 C										
505546	3	5	100	1	1301	1624	1898	Flexibar 3MTC 5x100x1	1.60	2.02
505543	3	8	80	1	1341	1674	1956	Flexibar 3MTC 8x80x1	1.65	2.12
505547	3	6	100	1	1414	1765	2062	Flexibar 3MTC 6x100x1	1.60	2.02
505544	3	10	80	1	1484	1851	2164	Flexibar 3MTC 10x80x1	1.65	2.12
2000 < Ampacity @ Delta T = 45 C										
505548	3	8	100	1	1598	1994	2330	Flexibar 3MTC 8x100x1	1.60	2.02
505549	3	10	100	1	1765	2203	2574	Flexibar 3MTC 10x100x1	1.60	2.02
505550	3	12	100	1	1920	2396	2800	Flexibar 3MTC 12x100x1	1.60	2.02

ADMISSIBLE CURRENTS: This table indicates the temperature rise produced by chosen current in the given section. This calculation does not take into account the heat dissipation from the switch gear.

Flexibar Standard

CERTIFICATION & APPROVALS

- International Commission Electrotechnique (IEC) - Meets all requirements of IEC 60439.1 & IEC 61439.1
- UL 67 Recognized component in the "Panelboard and Switchboard accessories - component" category (UL file E125470) for US and Canadian territory
- UL 758 Recognized component in the "Appliance wiring material - component" category style 10531 (UL file E316390) and category style 11343 (UL file E316390)
- Bureau Veritas Certified - No. 02859/DOBV. Ship application
- Canadian Standards Association - CSA certified as appliance wiring material for a maximum of 1000 volts. File N° 090005 (CAN/CSA - C22.2)
- American Bureau of Shipping (ABS) - Certificate No. 08-HS365878-1-PDA-DUP - Marine & Offshore Applications
- CE Conformity
- EAC compliant
- RoHS compliant
- Class II Conductors (IEC 61439-1. Chapter 8.4.4 - Protection by total insulation)



Flexibar Standard Part Numbers

2 METERS TINNED COPPER

Part Number	Flexibar Description	lbs
505051	Flexibar 2MTC 3x9x0.8	0.95
505052	Flexibar 2MTC 6x9x0.8	1.79
505053	Flexibar 2MTC 3x13x0.5	1.00
505054	Flexibar 2MTC 6x13x0.5	1.74
505055	Flexibar 2MTC 4x15x0.8	2.25
505056	Flexibar 2MTC 6x15x0.8	3.31
505059	Flexibar 2MTC 2x15x0.8	1.12

All Flexibar cross sections can be bent, folded or twisted with a small bending radius for shorter and more compact power connections, from 125A up to 4500A applications.

3 METERS TINNED COPPER

Part Number	Flexibar Description	lbs
505501	Flexibar 3MTC 2X20X	13.47
505502	Flexibar 3MTC 3X20X1	4.92
505503	Flexibar 3MTC 4X20X1	5.88
505504*	Flexibar 3MTC 5X20X1	7.11
505505*	Flexibar 3MTC 6X20X1	8.33
505506	Flexibar 3MTC 2X24X1	4.1
505507	Flexibar 3MTC 3X24X1	5.56
505508	Flexibar 3MTC 4X24X1	6.99
505509*	Flexibar 3MTC 5X24X1	8.44
505510*	Flexibar 3MTC 6X24X1	9.9
505511*	Flexibar 3MTC 8X24X1	12.81
505512*	Flexibar 3MTC 10X24X1	15.7
505513	Flexibar 3MTC 2X32X1	5.34
505514	Flexibar 3MTC 3X32X1	7.28
505515	Flexibar 3MTC 4X32X1	9.19
505516*	Flexibar 3MTC 5X32X1	11.11
505517*	Flexibar 3MTC 6X32X1	13.03
505518*	Flexibar 3MTC 8X32X1	16.87
505519*	Flexibar 3MTC 10X32X1	20.72
505521	Flexibar 3MTC 3X40X1	8.99
505522	Flexibar 3MTC 4X40X1	11.38
505523*	Flexibar 3MTC 5X40X1	13.78
505524*	Flexibar 3MTC 6X40X1	16.16
505525*	Flexibar 3MTC 8X40X1	20.94
505526*	Flexibar 3MTC 10X40X1	25.73
505551*	Flexibar 3MTC 6X45X1	18.15
505527	Flexibar 3MTC 3X50X1	11.13
505528*	Flexibar 3MTC 4X50X1	14.11
505529*	Flexibar 3MTC 5X50X1	17.09
505530*	Flexibar 3MTC 6X50X1	20.08
505531*	Flexibar 3MTC 8X50X1	26.04
505532*	Flexibar 3MTC 10X50X1	32.01
505533	Flexibar 3MTC 3X63X1	15.04
505534*	Flexibar 3MTC 4X63X1	17.68
505535*	Flexibar 3MTC 5X63X1	21.43
505536*	Flexibar 3MTC 6X63X1	25.18
505537*	Flexibar 3MTC 8X63X1	32.65
505540*	Flexibar 3MTC 4X80X1	22.33
505541*	Flexibar 3MTC 5X80X1	27.07
505542*	Flexibar 3MTC 6X80X1	31.81
505543*	Flexibar 3MTC 8X80X1	41.31
505546*	Flexibar 3MTC 5X100X1	33.73
505547*	Flexibar 3MTC 6X100X1	39.65
505548*	Flexibar 3MTC 8X100X1	51.5
505549*	Flexibar 3MTC 10X100X1	63.36
505550*	Flexibar 3MTC 12X100X1	75.2

* nVent ERIFLEX patent insulation

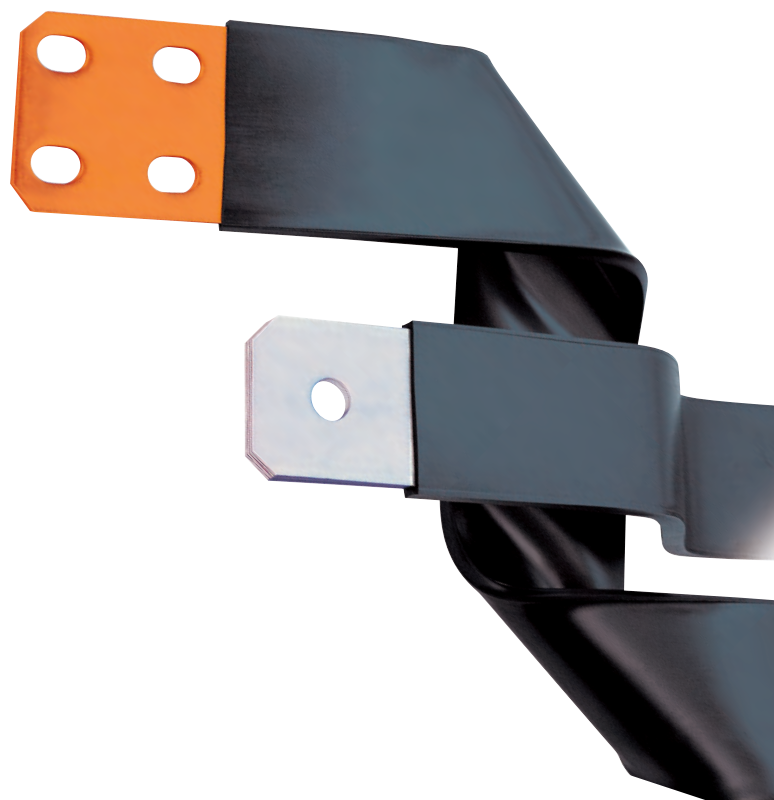

Flexibar Summum

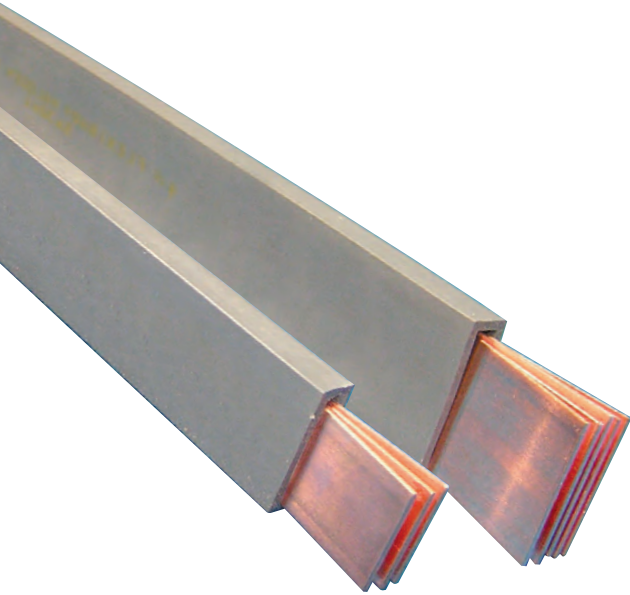

Flexibar Summum HALOGEN FREE - HIGH TEMPERATURE

- Halogen-free
- High current density
- High ambient temperature
- High flexibility
- High insulation value

Flexibar Summum

- Conductor in electrolytic copper
 - Laminates thickness 1 mm
- Insulation in silicone compound
 - Working temperature: -50°C up to 280°C (315°C short time)
 - Low smoke
 - High UV & ozone withstanding
 - Self-extinguishing: UL 94 V O
 - Elongation: 400% minimum
 - Tear resistance: 20 KN/m minimum
 - Thickness: 2 mm ± 0.2 mm
 - Dielectric strength: 20 KV/mm
 - Maximum continuous voltage: 1000 V AC/ 1500 V DC
 - American Bureau of Shipping (ABS) - Certificate No. 08-HS365878-1-PDA-DUP - Marine & Offshore Applications
 - IEC 60439.1
 - IEC 61439.1

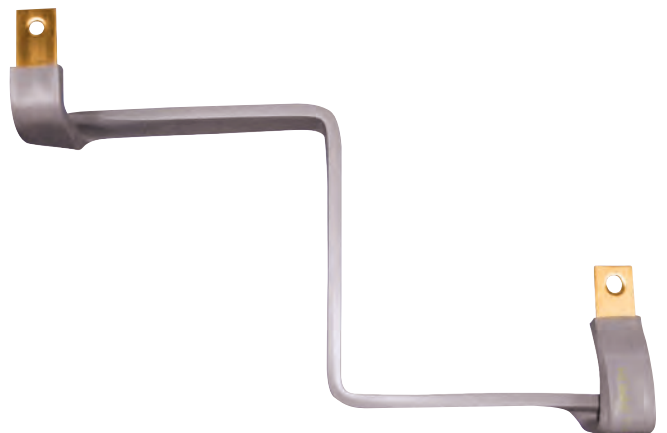

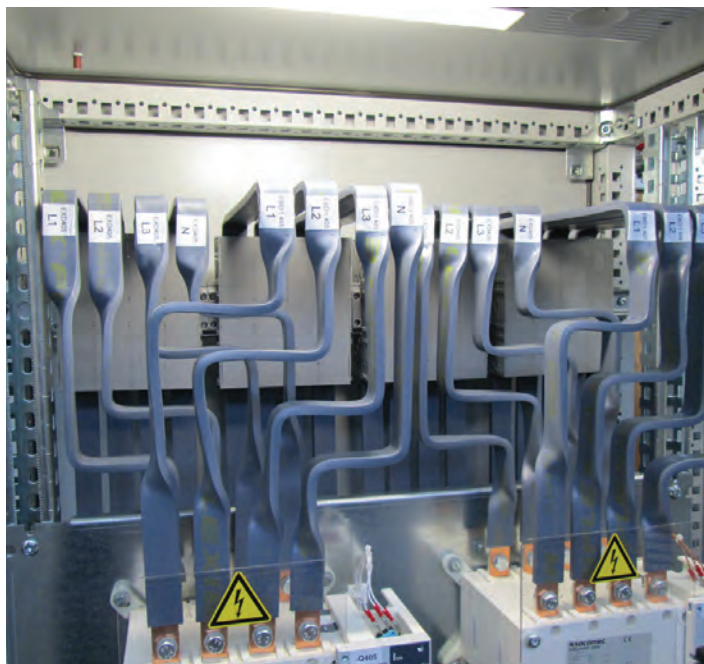

On request: Tinned Flexibar Summum





2 METER RED COPPER

Part Number	Flexibar Description	 Kg	Section mm ²	IEC [®] Ampacity ΔT (°k)					Current Coefficient		
				70	60	50	40	30			
566490	Flexibar Summum 2 M 2 x 20 x 1	5	1.05	40	326	300	275	246	214	1.72	2.25
566500	Flexibar Summum 2 M 3 x 20 x 1	5	1.42	60	428	395	360	323	280	1.72	2.25
566510	Flexibar Summum 2 M 4 x 20 x 1	5	1.78	80	476	440	402	360	312	1.72	2.25
566520	Flexibar Summum 2 M 5 x 20 x 1	5	2.15	100	498	460	420	376	326	1.72	2.25
566550	Flexibar Summum 2 M 2 x 24 x 1	5	1.24	48	450	416	380	340	295	1.72	2.25
566560	Flexibar Summum 2 M 3 x 24 x 1	5	1.68	72	490	453	413	370	320	1.72	2.25
566570	Flexibar Summum 2 M 4 x 24 x 1	5	2.12	96	550	540	465	416	360	1.72	2.25
566580	Flexibar Summum 2 M 5 x 24 x 1	5	2.55	120	608	563	514	460	398	1.72	2.25
566590	Flexibar Summum 2 M 6 x 24 x 1	5	2.99	144	670	620	566	506	438	1.72	2.25
566630	Flexibar Summum 2 M 3 x 32 x 1	5	2.2	96	570	525	480	430	372	1.72	2.25
566640	Flexibar Summum 2 M 4 x 32 x 1	5	2.78	128	648	600	548	490	425	1.72	2.25
566650	Flexibar Summum 2 M 5 x 32 x 1	5	3.36	160	758	702	640	573	496	1.72	2.25
566660	Flexibar Summum 2 M 6 x 32 x 1	5	3.94	192	846	783	715	640	555	1.72	2.25
566670	Flexibar Summum 2 M 8 x 32 x 1	5	5.1	256	1018	943	860	770	667	1.72	2.25
566720	Flexibar Summum 2 M 5 x 40 x 1	5	4.16	200	900	832	760	680	590	1.72	2.25
566730	Flexibar Summum 2 M 6 x 40 x 1	5	4.89	240	1018	943	860	770	667	1.72	2.25
566750	Flexibar Summum 2 M 10 x 40 x 1	5	7.78	400	1400	1295	1181	1055	915	1.72	2.25
566780	Flexibar Summum 2 M 5 x 50 x 1	5	5.17	250	1100	1016	930	830	718	1.72	2.25
566800	Flexibar Summum 2 M 8 x 50 x 1	2	7.87	400	1393	1290	1175	1050	912	1.72	2.25
566810	Flexibar Summum 2 M 10 x 50 x 1	2	9.68	500	1650	1525	1395	1245	1080	1.72	2.25

Product not available in all location – on demand

ADMISSIBLE CURRENTS: This table indicates the temperature rise produced by chosen current in the given section. This calculation does not take into account the heat dissipation from the switch gear.

Some photographs in the Flexibar Summum section may actually be using Flexibar

Accessories

END COVER 20, 24 & 32

- **End Cover 20:** Kit 250A T, Kit 250A TN, IBS 25, IBS 50, IBSB 50 and IBSB 70
- **End Cover 24:** 24 mm and IBSB 100
- **End Cover 32:** Kit 630A T, Kit 630A TN, IBSBR 120, 185 and 240
- Transparent cover Visual inspection
- Halogen-free
- Self-extinguishing: UL 94 V-0
- RoHS compliant
- Easy-fitting after bolting
- IEC 60439.1
- IEC 61439.1



Part No.	Description		kg/lbs
541774	End Cover 20	12	0.19/0.42
541775	End Cover 24	12	0.22/0.48
541776	End Cover 32	12	0.26/0.57



SPACER CLAMPS

- Easy to install
- Fixes and maintains the weight of Flexibar range
- Facilitates cooling

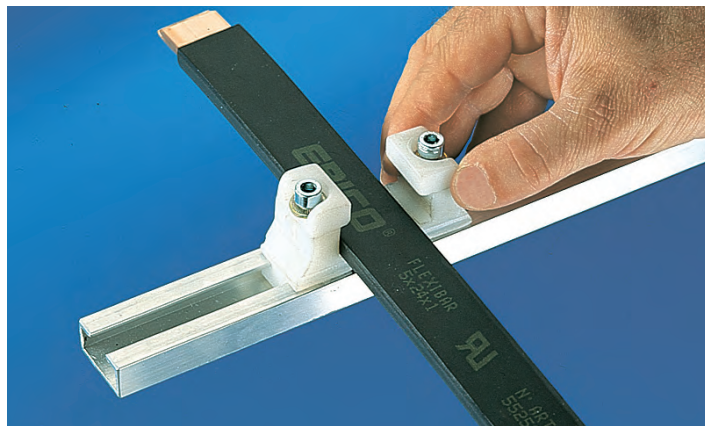

UFS KIT SUPPORT

Assembly comprised of a 2 m aluminum section and 24 retaining blocks made of glass-reinforced halogen-free polyamide.

- Possible to make up 3 supports, 650 mm long each for 4 Flexibar range
- Recommended distance between clamps: 16 inches max

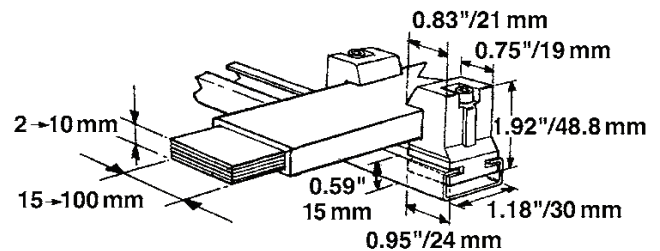

Part No.	Description		lbs
553590	UFS Kit	1	5.07





Accessories

FS

SPACER CLAMP

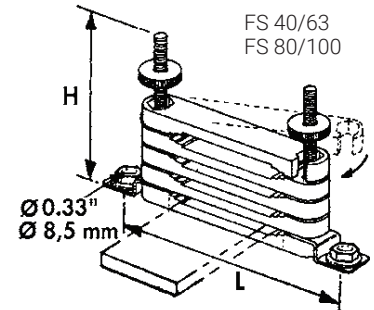
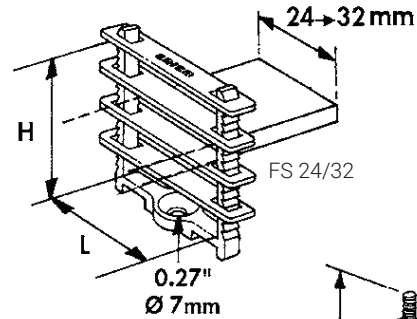
- Ensures correct support for Flexibar range, IBSB & IBSBR in parallel, without damage to the insulation
- Maintains correct space for optimum cooling
- 4 Flexibar range in parallel maximum
- UL 67
- Recommended distance between clamps: 16 inches



Part No.	Description	Type*	H mm	L mm		 lbs
553550	FS 24	=< 24 mm	53	30	25	0.03
553560	FS 32	=< 32 mm	53	38	25	0.04
553570	FS 40-63	40-50 & 63 mm	95	150	10	2.20
553580	FS 80-100	80/100 mm	140	200	10	5.51





* Type of Flexibar and IBS/IBSB/IBSBR

RFS

REINFORCED SUPPORT

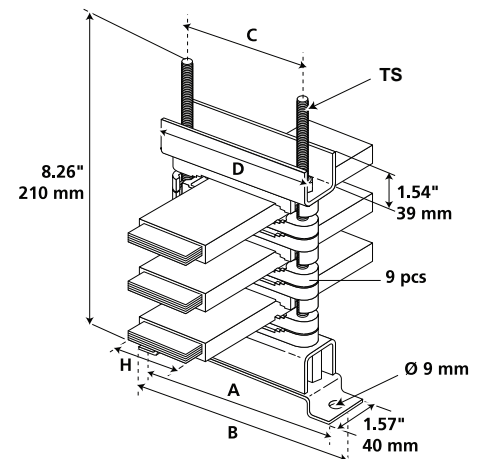
- Allows up to 8 Flexibar range in parallel.
- Easy mounting in the panel (0.984 pitch)
- Recommended distance between clamps: 16 inches



Part No.	Description	A mm	B mm	C mm	D mm	TS	Flexibar H mm		 lbs
553370	RFS 40-63	150	175	90	120	M8	40=>63	1	0.53
553380	RFS 80-100	200	225	140	170	M10	80=>100	1	0.66

Accessories

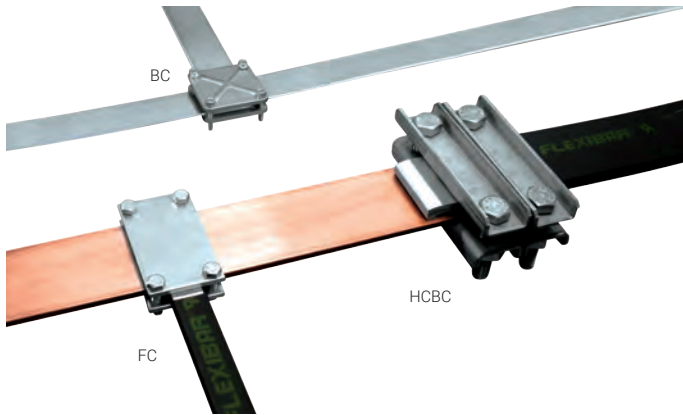

CONNECTING CLAMPS

- Excellent electrical contact
- Saves space
- Fast installation
- Ideal for "on site" modifications

FC

CLAMP

- Clamping capacity: 0.79 inches
- 2 zinc plated steel plates complete with M8 screws 8.8 class

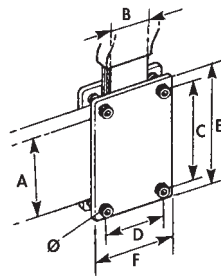

Part No.	Description	A In	B In	C In	D In	E In	F In	Torque ft/lbs		lbs
553020	FC 50 x 24	2	20-24	2.32	1.42	2.95	2.05	7.37	3	0.7
553030	FC 50 x 32	2	32	2.32	1.73	2.95	2.36	7.37	3	0.8
553040	FC 50 x 40	2	40	2.32	2.05	2.95	2.68	7.37	3	0.91
553050	FC 80 x 24	3.18	20-24	3.5	1.42	4.13	2.05	7.37	3	0.95
553060	FC 80 x 32	3.18	32	3.5	1.73	4.13	2.36	7.37	3	1.08
553070	FC 80 x 50	3.18	50	3.5	2.44	4.13	3.07	7.37	3	1.41
568700	FC 100 x 32	3.97	32	4.29	1.73	4.92	2.36	7.37	3	1.47
568730	FC 120 x 32	4.4	32	5.08	1.73	5.70	2.36	7.37	3	1.67

BC

RIBBED-STEEL BUSBAR CLAMP

- Clamping capacity: 0.79 inches
- 2 ribbed zinc-plated hardened- steel plates complete with screws
- Maximum clamping capacity is 50 mm using longer screws SAE Grade 5
- UL® 67 recognized

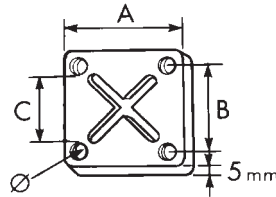

Part No.	Description	A In	B In	C In	Ø In	Torque ft/lbs		lbs
553200	BC 30	2.2	1.65	1.37	M6	5.16	8	0.68
553210	BC 40	2.6	2.05	1.77	M6	5.16	8	0.81
553220	BC 50	3.26	2.52	2.16	M8	14.75	8	1.30
553230	BC 63	3.66	2.91	2.55	M8	14.75	4	1.63
553250	BC 80	4.64	3.78	3.34	M10	29.50	4	2.60
553260	BC 100	5.67	4.64	4.21	M10	29.50	4	3.79

HCBC

HIGH CURRENT BUSBAR CLAMP

- Clamping capacity: 1.58 inches
- This modular busbar clamp is designed with non-magnetic materials for high current connections between Flexibar and rigid busbars such as transformer terminals
- Design assures rigidity and even contact pressure
- Use 2 clamps to guarantee the contact pressure

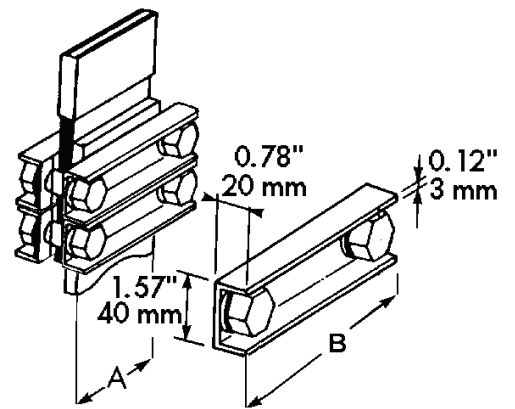

Part No.	Description	A In	B In	Torque ft/lbs		lbs
553100	HSBC 80	3.15	5.5	74	1	1.85
553110	HSBC 100	3.94	6.3	74	1	2.03
553120	HSBC 120	4.72	7.2	74	1	2.20

Accessories





FBC

CONNECTORS FOR CONNECTING WITHOUT DRILLING

- No need to drill to a 5 mm or 10 mm thick busbar
- Cables from 1 mm² up to 185 mm² or Flexibar range width 6 mm to 20 mm
- Self-support of connector during mounting procedure
- IEC 60 999



ERIFLEX FLEXIBAR TYPE

Connectors for busbar thickness 5 mm

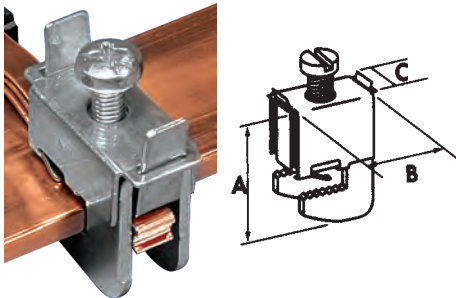
Part No.	Description	A mm	B mm	C mm	Flexibar Type (mm)	Torque N.m	Cable Size mm ²		 Kg
553405	FBC 5 x 4	23	29	11	-	2	1 - 4	15	0.016
553400	FBC 5 x 6	28	31	14	6	3	2.5 - 16	15	0.028
553410	FBC 5 x 9	36	40	19	9	6-8	16 - 50	15	0.068
553510	FBC 5 x 15.5	44	40	25	15.5	10-12	35 - 70	15	0.110
553520	FBC 5 x 20	48	40	31	20	12-15	70 - 185	15	0.132



Connectors for busbar thickness 10 mm



Part No.	Description	A mm	B mm	C mm	Flexibar Type (mm)	Torque N.m	Cable Size mm ²		 Kg
553505	FBC 10 x 4	28	29	12	-	2	1 - 4	15	0.018
553430	FBC 10 x 6	33	31	14	6	3	2.5 - 16	15	0.030
553440	FBC 10 x 9	42	40	19	9	6 - 8	16 - 50	15	0.070
553530	FBC 10 x 15.5	49	40	25	15.5	10 - 12	35 - 70	15	0.112
553540	FBC 10 x 20	54	40	31	20	12 - 15	70 - 185	15	0.138

QCC

CLAMPS

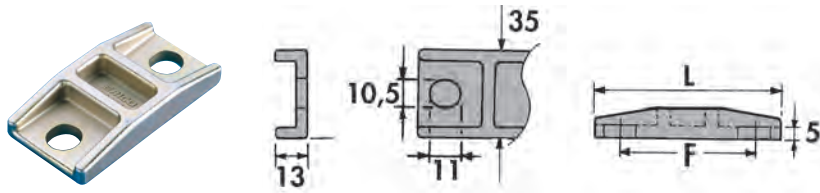
- For Flexibar thickness < 5 mm = 1 clamp
- For Flexibar thickness > 5 mm = 2 clamps



Part No.	Description	Flexibar width		L mm	F mm		 Kg
		min. mm	max. mm				
561210	QCC 15.5/32	15.5	32	70	50	5	0.112
561220	QCC 40/63	40	63	95	75	5	0.158

Flexibar Hydraulic Work Center

To discover our full range of tools, please request a copy of our specific "Hydraulic & Manual Tools" brochure.



Hydraulic Busbar & Flexibar Puncher



Hydraulic Busbar Bender



Hydraulic Busbar Cutter



Shearing Tool Ruler



Hydraulic Pump & Foot Controller



Hydraulic Flexibar Shearing Tool



Shearing Tool Guide

Flexibar Manual Work Center

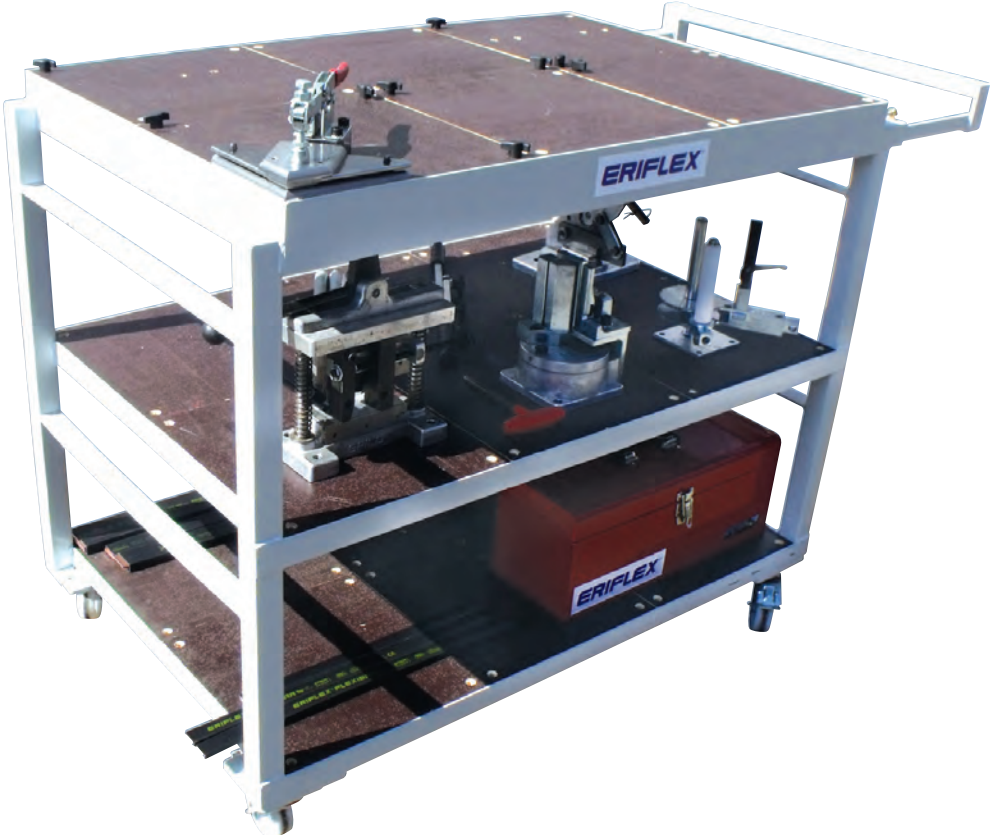

Shearing Tool



Bending Tool



Twisting Tool



Drilling Tool

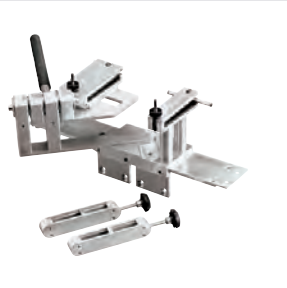

Folding Tool



Stripping Tool



Stripping Knife



Bending Tool

Insulated Braided Conductor (IBSB & IBSBR)



Insulated braided conductors suitable for all the main molded case circuit breakers worldwide.



IDEAL CONNECTION FOR MOLDED CASE CIRCUIT BREAKERS

The IBSB and IBSBR range can be used as an alternative to cable for all low-voltage power applications. It is suitable and connectable for molded case circuit breaker ranges, including most compact breakers on the market. From 80 A up to 630 A circuit breakers, you can directly connect the IBSB/IBSBR on the front access terminals breaker without additional accessories, such as angular connectors, spreaders, ring terminal connectors or extenders. No lugs and no cutting, stripping, or crimping are necessary.

Simple! Quick! Ready to use!

INSULATED BRAIDED CONDUCTOR TECHNICAL FEATURES

- IBSB and IBSBR are specially designed and developed to be suitable and connectable for molded case circuit breaker ranges, including most compact breakers on the market
- IBSB and IBSBR are formed with high-quality electrolytic copper wire (diameter 0.15 mm for maximum flexibility)
- Material savings: Integral palm without lugs or terminals
- Quick and easy to install: Ready to use. No cutting, stripping, crimping or punching. Less installation time
- Weight savings: A flat braid weights less than a cable (with insulation) and lugs. Offers better copper usage (Skin Effect)
- The insulation is a high-resistance self-extinguishing PVC +105°C working temperature maximum
- Full application range: 80 A to 630 A (section 25, 50, 70, 100, 120, 185 and 240 mm²), with 230 up to 1030 mm length
- Reliability – No extra contact due to the lugs being crimped at the extremities of the cables. Integral palm without tin addition or crimped lug for an excellent electrical contact
- Resistant to vibration - ideal alternative to cable

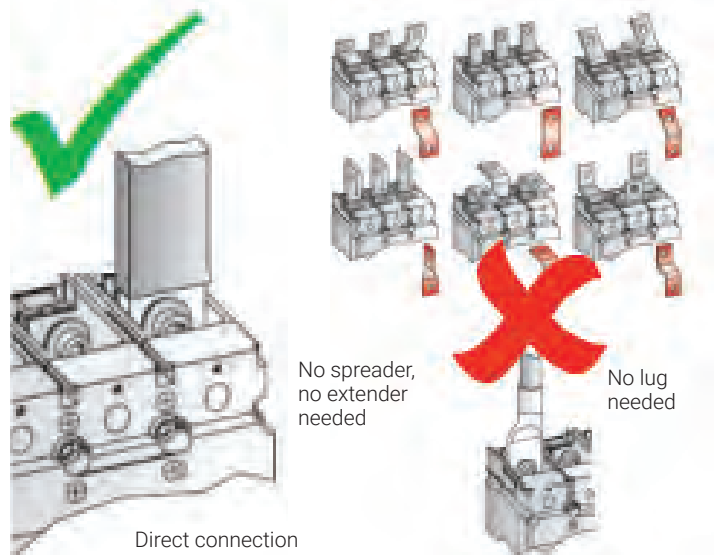



THE OPTIMIZED ALTERNATIVE TO CABLE - READY TO USE.

nVent ERIFLEX has developed a unique, state-of-the-art manufacturing line to massivate directly the palms of IBSB and IBSBR braids.

This innovative manufacturing process provides an effective electrical contact, due to the integral palms, without the addition of tin or crimped lugs. This process welds the flexible braid and brings back a solid tinned or red copper block as a palm. Unlike the traditional press-welded palms process, nVent ERIFLEX process is suitable for red copper and tinned plated copper. The electrical contact between each wire is optimized.

This nVent ERIFLEX process also helps to eliminate moisture issues in the palms. By using crimped lugs in a severe environment, moisture can enter in the lug (often by capillarity) and create corrosion between each wire. After several years, the electrical contact between each wire can deteriorate and alter the electrical conductivity of the equipment. The corrosion in the palm is impossible to remove without changing the element.

This process produces RoHS products; no additional substances are added to the tinned-plated wires during the manufacturing process.

Insulated Braided Conductor (IBSB & IBSBR)



Comparison of tensile strength

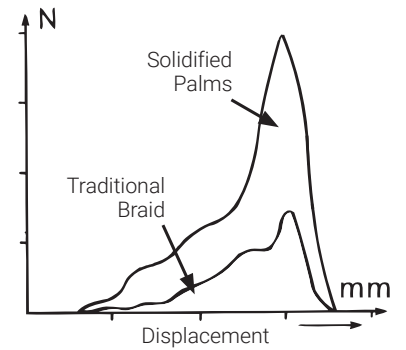

Nominal clamping force

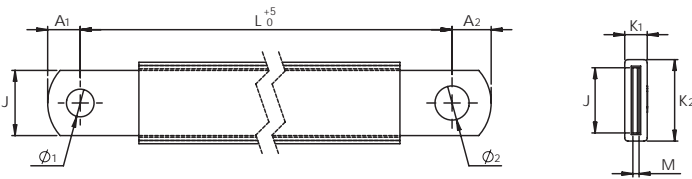

TECHNICAL DATA

- Excellent electrical contact with integral palm construction
- Good tensile strength

Insulation

- High resistance: vinyl compound
- Maximum working temperature: + 105° C
- Self-extinguishable: UL 94 V0
- Dielectric strength: 20 kV/mm
- Max. working voltage: 1000 V AC-1500 V DC-IEC & UL 758
- Max. working voltage: 600V AC/DC – UL 67
- Class II Conductors (IEC 61439-1. Chapter 8.4.4 Protection by total insulation)

Braid



- Tinned (IBSB 25-50-70-100) or red (IBSBR 120-185-240) electrolytic copper
- Wire diameter: 0.15 mm for maximum flexibility - According to EN 13602
- Upper resistance to vibration

CERTIFICATION & APPROVALS

- IEC 60439.1 & IEC 61439.1
- cRUus per UL67 & CAN/CSA C22.2 No. 29 (File E125470)
- RU per UL758 (E316390)
- CE conformity
- RoHS compliant
- American Bureau of Shipping (ABS) - Certificate No. 13-HS1070074-PDA - Marine & Offshore Applications
- Bureau Veritas Marine and offshore division for classification of steel ships and according to IEC 60092
- CSA C22.2 No 210 for appliance wiring material products
- EAC

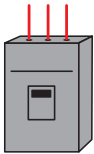
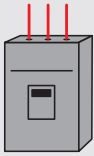
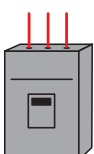
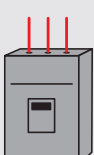
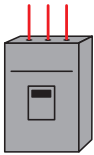
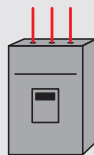
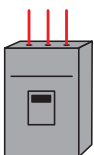

INSULATED BRAIDED CONDUCTORS TECHNICAL CHARACTERISTICS

Use with circuit breaker	Part Number	Description	S mm ²	L mm	Ø1 mm	Ø2 mm	A1 mm	A2 mm	J mm	M mm	K1 mm	K2 mm		 Kg	
IBSB - Tinned Copper															
125/160A  IBSB 25	558500	IBSB 25-230-6	25	230	6.5	6.5	7.5	7.5	12	2.8	9	18	10	0.08	
	558501	IBSB 25-330-6	25	330	6.5	6.5	7.5	7.5	12	2.8	9	18	10	0.11	
	558502	IBSB 25-430-6	25	430	6.5	6.5	7.5	7.5	12	2.8	9	18	10	0.15	
	558503	IBSB 25-530-6	25	530	6.5	6.5	7.5	7.5	12	2.8	9	18	10	0.18	
	558504	IBSB 25-630-6	25	630	6.5	6.5	7.5	7.5	12	2.8	9	18	10	0.22	
	558505	IBSB 25-830-6	25	830	6.5	6.5	7.5	7.5	12	2.8	9	18	10	0.28	
	558506	IBSB 25-1030-6	25	1030	6.5	6.5	7.5	7.5	12	2.8	9	18	10	0.35	
250A  IBSB 50	558507	IBSB 50-230-8-10	50	230	8.5	10.5	9	11	20	3	9	27	10	0.15	
	558508	IBSB 50-330-8-10	50	330	8.5	10.5	9	11	20	3	9	27	10	0.21	
	558509	IBSB 50-430-8-10	50	430	8.5	10.5	9	11	20	3	9	27	10	0.27	
	558510	IBSB 50-530-8-10	50	530	8.5	10.5	9	11	20	3	9	27	10	0.33	
	558511	IBSB 50-630-8-10	50	630	8.5	10.5	9	11	20	3	9	27	10	0.39	
	558512	IBSB 50-830-8-10	50	830	8.5	10.5	9	11	20	3	9	27	10	0.52	
	558513	IBSB 50-1030-8-10	50	1030	8.5	10.5	9	11	20	3	9	27	10	0.64	
300A  IBSB 70	558514	IBSB 70-230-8-10	70	230	8.5	10.5	9	11	20	4.3	11	27	10	0.197	
	558515	IBSB 70-330-8-10	70	330	8.5	10.5	9	11	20	4.3	11	27	10	0.28	
	558516	IBSB 70-430-8-10	70	430	8.5	10.5	9	11	20	4.3	11	27	10	0.362	
	558517	IBSB 70-530-8-10	70	530	8.5	10.5	9	11	20	4.3	11	27	10	0.444	
	558518	IBSB 70-630-8-10	70	630	8.5	10.5	9	11	20	4.3	11	27	10	0.527	
	558519	IBSB 70-830-8-10	70	830	8.5	10.5	9	11	20	4.3	11	27	10	0.692	
	558520	IBSB 70-1030-8-10	70	1030	8.5	10.5	9	11	20	4.3	11	27	10	0.857	
350A  IBSB 100	558521	IBSB 100-230-8-10	100	230	8.5	10.5	9	11	24	5	13	31	10	0.27	
	558522	IBSB 100-330-8-10	100	330	8.5	10.5	9	11	24	5	13	31	10	0.39	
	558523	IBSB 100-430-8-10	100	430	8.5	10.5	9	11	24	5	13	31	10	0.50	
	558524	IBSB 100-530-8-10	100	530	8.5	10.5	9	11	24	5	13	31	10	0.62	
	558525	IBSB 100-630-8-10	100	630	8.5	10.5	9	11	24	5	13	31	10	0.73	
	558526	IBSB 100-830-8-10	100	830	8.5	10.5	9	11	24	5	13	31	10	0.96	
	558527	IBSB 100-1030-8-10	100	1030	8.5	10.5	9	11	24	5	13	31	10	1.19	
IBSBR - Red Copper															
400A  IBSBR 120	558528	IBSBR 120-230-10	120	230	10.5	10.5	11	11	32	4.4	12	39	2	0.33	
	558529	IBSBR 120-330-10	120	330	10.5	10.5	11	11	32	4.4	12	39	2	0.47	
	558530	IBSBR 120-430-10	120	430	10.5	10.5	11	11	32	4.4	12	39	2	0.6	
	558531	IBSBR 120-530-10	120	530	10.5	10.5	11	11	32	4.4	12	39	2	0.74	
	558532	IBSBR 120-630-10	120	630	10.5	10.5	11	11	32	4.4	12	39	2	0.88	
	558533	IBSBR 120-830-10	120	830	10.5	10.5	11	11	32	4.4	12	39	2	1.15	
	558534	IBSBR 120-1030-10	120	1030	10.5	10.5	11	11	32	4.4	12	39	2	1.43	
500A  IBSBR 185	558535	IBSBR 185-330-10-12	185	330	10.5	12.5	12	14	32	7.1	16	39	2	0.7	
	558536	IBSBR 185-430-10-12	185	430	10.5	12.5	12	14	32	7.1	16	39	2	0.9	
	558537	IBSBR 185-530-10-12	185	530	10.5	12.5	12	14	32	7.1	16	39	2	1.1	
	558538	IBSBR 185-630-10-12	185	630	10.5	12.5	12	14	32	7.1	16	39	2	1.3	
	558539	IBSBR 185-830-10-12	185	830	10.5	12.5	12	14	32	7.1	16	39	2	1.7	
	558540	IBSBR 185-1030-10-12	185	1030	10.5	12.5	12	14	32	7.1	16	39	2	2.1	
630A  IBSBR 240	558541	IBSBR 240-330-10-12	240	330	10.5	12.5	12	14	32	9.2	18.5	39	2	0.89	
	558542	IBSBR 240-430-10-12	240	430	10.5	12.5	12	14	32	9.2	18.5	39	2	1.14	
	558543	IBSBR 240-530-10-12	240	530	10.5	12.5	12	14	32	9.2	18.5	39	2	1.4	
	558544	IBSBR 240-630-10-12	240	630	10.5	12.5	12	14	32	9.2	18.5	39	2	1.65	
	558545	IBSBR 240-830-10-12	240	830	10.5	12.5	12	14	32	9.2	18.5	39	2	2.16	
	558546	IBSBR 240-1030-10-12	240	1030	10.5	12.5	12	14	32	9.2	18.5	39	2	2.67	

Insulated Braided Conductor (IBS)



IBS 25
IBS 50

IBS 120
IBS 185
IBS 240



TECHNICAL DATA

- Intensity = 100A up to 1000A
- Excellent electrical contact
- Good tensile strength

INSULATION

- High resistance: vinyl compound
- Max. working temperature: + 105°C
- Self-extinguishable: UL 94 VO
- Dielectric strength: 20 kV/mm
- Max. working voltage: 1000 V AC-1500 V DC-IEC & UL 758
- Max. working voltage: 600V AC/DC – UL 67

BRAID

- Tinned electrolytic copper for better corrosion protection
- Wire diameter: 0.15 mm for maximum flexibility
- Strong resistance to vibration

CERTIFICATION & APPROVAL

- IEC 60439.1 & IEC 61439.1
- cRUus per UL67 & CAN/CSA C22.2 No. 29
- CE conformity
- RoHS compliant
- RU per UL758
- American Bureau of Shipping (ABS)
- CSA C22.2 No 210 for appliance wiring material products

DIELECTRIC TEST

- 3500 VAC, 1 minute according to the IEC 60439.1 standard (rated insulation voltage U_i 1000 VAC)
- 6000 VAC, 1 minute with 6 mA creepage current set up

FEATURES

- The ideal alternative to cable
- No cutting, no stripping, no crimping
- More flexible connection
- Pre-punched: ready to use
- Quick and easy to install
- Excellent electrical contact
- Tinned electrolytic copper for better corrosion protection
- Strong resistance to vibration
- Volume reduction inside the panel board

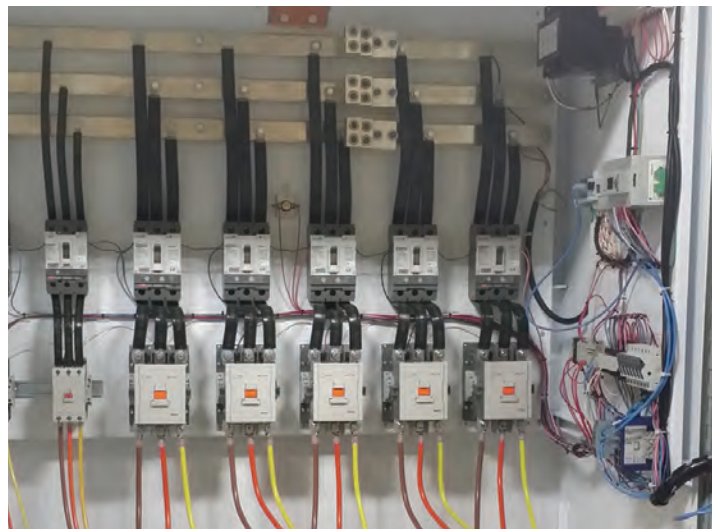

Insulated Braided Conductor (IBS)

IBS 25
IBS 50

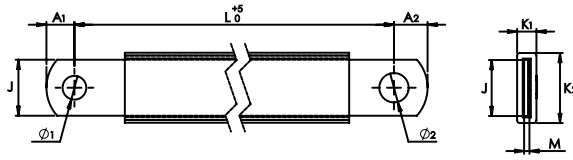

Part No.	IBS 25	S mm ²	L mm	Ø1 mm	Ø2 mm	A1 mm	A2 mm	J mm	M mm	K1 mm	K2 mm		Kg	
160 A	558240	IBS 25-230-8-10	25	230	8.5	10.5	10	12	20	1.9	6	25	10	0.095
	558241	IBS 25-330-8-10	25	330	8.5	10.5	10	12	20	1.9	6	25	10	0.14
	558242	IBS 25-430-8-10	25	430	8.5	10.5	10	12	20	1.9	6	25	10	0.17
	558243	IBS 25-530-8-10	25	530	8.5	10.5	10	12	20	1.9	6	25	10	0.21
	558244	IBS 25-630-8-10	25	630	8.5	10.5	10	12	20	1.9	6	25	10	0.25
	558249	IBS 25-830-8-10	25	830	8.5	10.5	10	12	20	1.9	6	25	10	0.33
	558250	IBS 25-1030-8-10	25	1030	8.5	10.5	10	12	20	1.9	6	25	10	0.41

Part No.	IBS 50	S mm ²	L mm	Ø1 mm	Ø2 mm	A1 mm	A2 mm	J mm	M mm	K1 mm	K2 mm		Kg	
250 A	558260	IBS 50-230-10	50	230	10.5	10.5	12	12	20	3.8	7.5	25	10	0.16
	558261	IBS 50-330-10	50	330	10.5	10.5	12	12	20	3.8	7.5	25	10	0.22
	558262	IBS 50-430-10	50	430	10.5	10.5	12	12	20	3.8	7.5	25	10	0.29
	558263	IBS 50-530-10	50	530	10.5	10.5	12	12	20	3.8	7.5	25	10	0.35
	558264	IBS 50-630-10	50	630	10.5	10.5	12	12	20	3.8	7.5	25	10	0.41
	558255	IBS 50-830-10	50	830	10.5	10.5	12	12	20	3.8	7.5	25	10	0.53
	558256	IBS 50-1030-10	50	1030	10.5	10.5	12	12	20	3.8	7.5	25	10	0.65

IBS 120
IBS 185
IBS 240

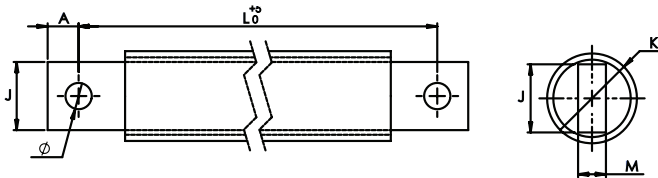

Part No.	IBS 120	S mm ²	L mm	Ø mm	A mm	J mm	M mm	K mm		Kg	
400 A	558270	IBS 120-330-10	120	330	10.5	12	24	10	27	2	0.51
	558271	IBS 120-430-10	120	430	10.5	12	24	10	27	2	0.67
	558272	IBS 120-530-10	120	530	10.5	12	24	10	27	2	0.82
	558273	IBS 120-630-10	120	630	10.5	12	24	10	27	2	0.98
	558274	IBS 120-830-10	120	830	10.5	12	24	10	27	2	1.29
	558276	IBS 120-1030-10	120	1030	10.5	12	24	10	27	2	1.6

Part No.	IBS 185	S mm ²	L mm	Ø mm	A mm	J mm	M mm	K mm		Kg	
500 A	558290	IBS 185-330-10	185	330	10.5	12	24	15	31	2	0.82
	558291	IBS 185-430-10	185	430	10.5	12	24	15	31	2	1.07
	558292	IBS 185-530-10	185	530	10.5	12	24	15	31	2	1.26
	558293	IBS 185-630-10	185	630	10.5	12	24	15	31	2	1.48
	558294	IBS 185-830-10	185	830	10.5	12	24	15	31	2	1.9
	558295	IBS 185-1030-10	185	1030	10.5	12	24	15	31	2	2.3

Part No.	IBS 240	S mm ²	L mm	Ø mm	A mm	J mm	M mm	K mm		Kg	
630 A	558280	IBS 240-330-12	240	330	12.5	13	32	15	36	2	1.03
	558281	IBS 240-430-12	240	430	12.5	13	32	15	36	2	1.34
	558282	IBS 240-530-12	240	530	12.5	13	32	15	36	2	1.65
	558283	IBS 240-630-12	240	630	12.5	13	32	15	36	2	1.96
	558284	IBS 240-830-12	240	830	12.5	13	32	15	36	2	2.58
	558285	IBS 240-1030-12	240	1030	12.5	13	32	15	36	2	3.2

IBSHY Insulated Braided Conductor for Compact Circuit Breakers



FEATURES

- Suitable for all main 125/160 A electrical devices and specifically molded case circuit breakers
- Resistant to vibration, improving reliability and performance
- Improves assembly flexibility and aesthetics
- Quick and easy installation
- No additional cutting, stripping, crimping and punching needed
- Small wire diameter provides maximum flexibility
- Halogen-free solution for applications requiring a low smoke solution
- Conforms to NF EN 45545 obtaining an HL2 classification for chapters R22 and R23
- High working temperature
- RoHS compliant



IBSHY INSULATED BAIED CONDUCTOR SPECIFICATIONS

- Typical Application Current Rating: 160 A
- Finish: Tinned
- Material: Copper; Glass Fibre Reinforced Silicon
- Flammability Rating: UL 1441 VW-1
- Max Working Voltage. IEC (Ui): 1 000 VAC; 1 500 VDC
- Operating Temperature: from -60 °C to 250 °C
- Wire Diameter: 0.15 mm
- IEC 60439-1; IEC 61439-1 compliant

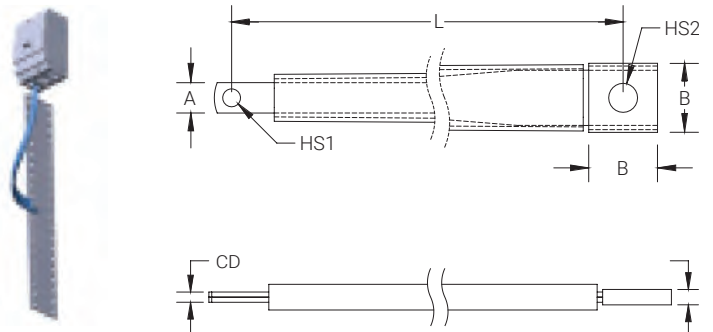

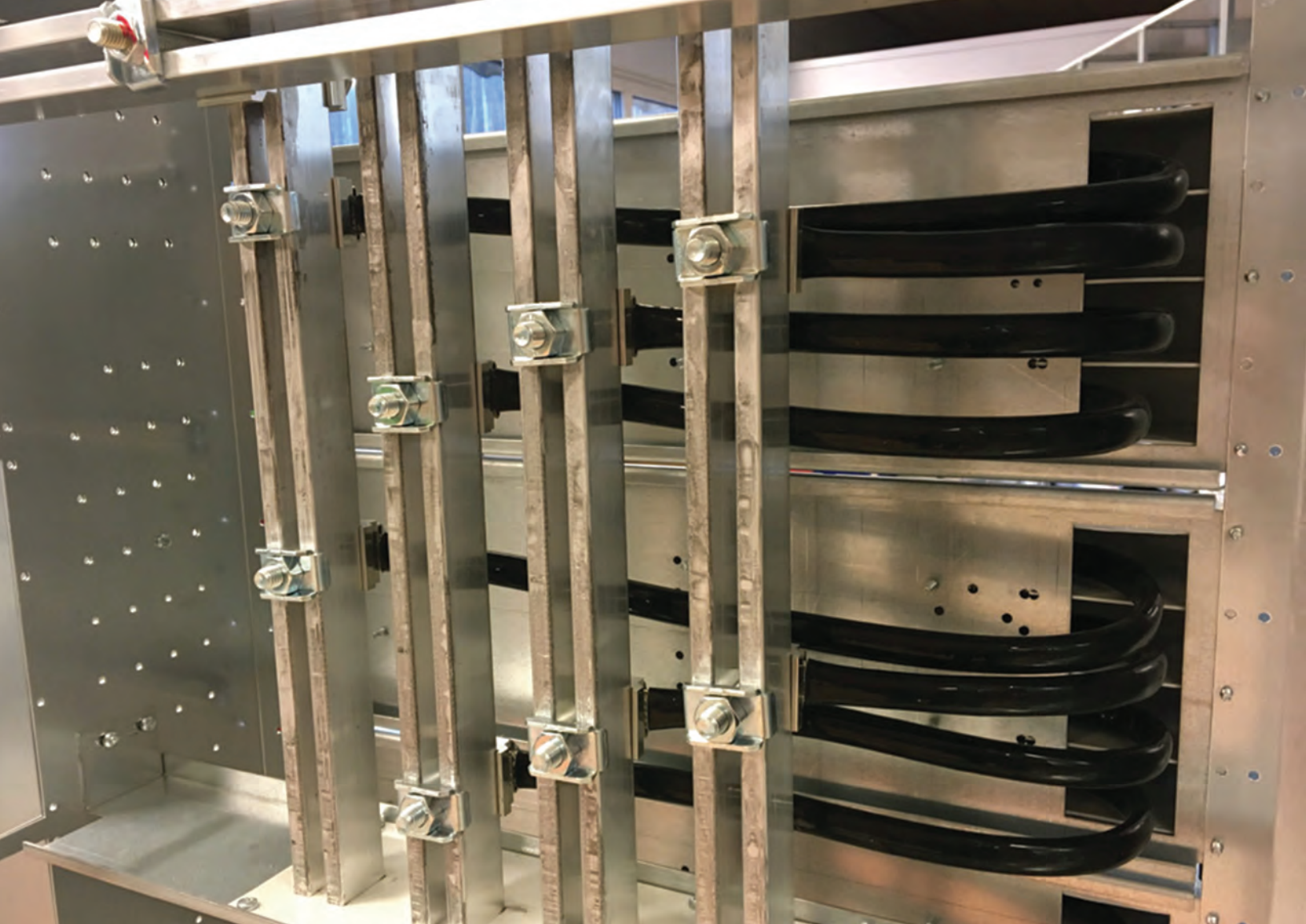

IBSHY INSULATED BAIDED CONDUCTOR TECHNICAL CHARACTERISTICS

Part No.	Article No.	Cross Section	Length L	A	B	C	D	Hole Size 1 HS1	Hole Size 2 HS2
IBSHY32-230	558584	32 mm ²	230 mm	11 mm	25 mm	3 mm	5 mm	6.5 mm	10.5 mm
IBSHY32-330	558586	32 mm ²	330 mm	11 mm	25 mm	3 mm	5 mm	6.5 mm	10.5 mm
IBSHY32-365	558587	32 mm ²	365 mm	11 mm	25 mm	3 mm	5 mm	6.5 mm	10.5 mm
IBSHY32-430	558588	32 mm ²	430 mm	11 mm	25 mm	3 mm	5 mm	6.5 mm	10.5 mm
IBSHY32-500	558589	32 mm ²	500 mm	11 mm	25 mm	3 mm	5 mm	6.5 mm	10.5 mm
IBSHY32-565	558591	32 mm ²	565 mm	11 mm	25 mm	3 mm	5 mm	6.5 mm	10.5 mm
IBSHY32-630	558592	32 mm ²	630 mm	11 mm	25 mm	3 mm	5 mm	6.5 mm	10.5 mm
IBSHY32-700	558593	32 mm ²	700 mm	11 mm	25 mm	3 mm	5 mm	6.5 mm	10.5 mm
IBSHY32-765	558594	32 mm ²	765 mm	11 mm	25 mm	3 mm	5 mm	6.5 mm	10.5 mm
IBSHY32-830	558595	32 mm ²	830 mm	11 mm	25 mm	3 mm	5 mm	6.5 mm	10.5 mm

Maximum Ampacity Ratings



Cross Section (mm ² /kcmil)	ΔT 30° C	ΔT 35° C	ΔT 40° C	ΔT 45° C	ΔT 50° C	ΔT 55° C	ΔT 60° C	ΔT 65° C	ΔT 70° C	ΔT 75° C	ΔT 80° C	ΔT 100° C	ΔT 120° C	2 Bar Current Coefficient	3 Bar Current Coefficient
	(A)	(A)	(A)	(A)	(A)	(A)	(A)	(A)	(A)	(A)	(A)	(A)			
32/63.15	142	153	164	174	184	193	201	209	217	225	235	263	290	1.6	2

ΔT = Temperature of conductors – Internal temperature of panel.

This table indicates the temperature rise produced by chosen current in the given section. This calculation does not take into account the heat dissipation from the switch gear.

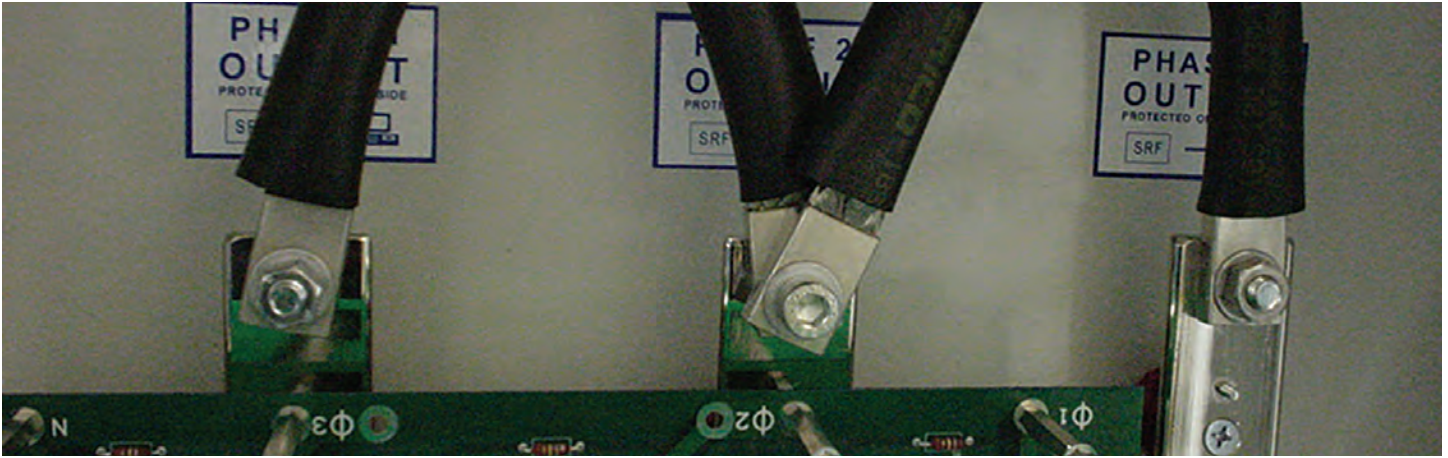
Insulated Braided Conductor (IBS, IBSB, IBSBR & IBSHY)



Insulated Braided conductor type	Section mm ²	ΔT (K)							Current Coefficient	
		30	40	45	50	55	60	70		
IBS 25	25	137	158	167	177	185	193	209	1.6	2
IBSB 25	25	116	134	142	150	157	164	177	1.6	2
IBS 50	50	213	246	260	274	288	301	325	1.6	2
IBSB 50	50	213	246	260	274	288	301	325	1.6	2
IBSB 70	70	226	261	277	291	306	319	345	1.6	2
IBSB 100	100	298	344	365	385	404	422	456	1.6	2
IBS 120	120	325	376	398	420	441	460	497	1.6	
IBSBR 120	120	363	419	444	468	491	513	554	1.6	2
IBS 185	185	407	470	499	526	552	576	622	1.6	
IBSBR 185	185	416	480	509	537	563	588	635	1.6	2
IBS 240	240	488	563	598	630	661	690	745	1.6	
IBSBR 240	240	556	642	681	718	753	786	849	1.6	2

ADMISSIBLE CURRENTS: This table indicates the temperature rise produced by chosen current in the given section. This calculation does not take into account the heat dissipation from the switch gear.

TEMPERATURE RISE OF CONDUCTOR = T₂ - T₁ = ΔT (K)

Ex.: For a current of 630A, with:

T₁ = 40°C - T₂ = 90°C

1) ΔT = 90 - 40 = 50K

2) In the 50°K column, find the closest current value to 630A.

K = Kelvin degree (temperature calculated, but not measurable.)

INSULATED BRAIDED CONDUCTOR IN PARALLEL

When using 2 or 3 insulated braided conductors in parallel for the same phase, use the current coefficient:

Ex.: IBSB 100 - ΔT° = 50K: 385 A

2 braids in parallel > 385 A x 1.6 = 616 A

3 braids in parallel > 385 A x 2 = 770 A

Selection of insulated braided conductor IBS, IBSB & IBSBR according to the internal temperature of the panel.

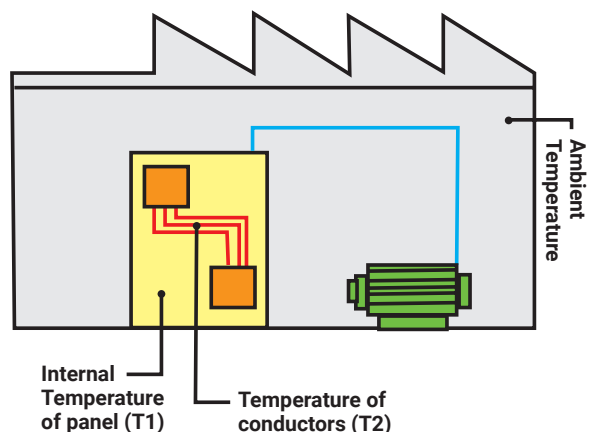

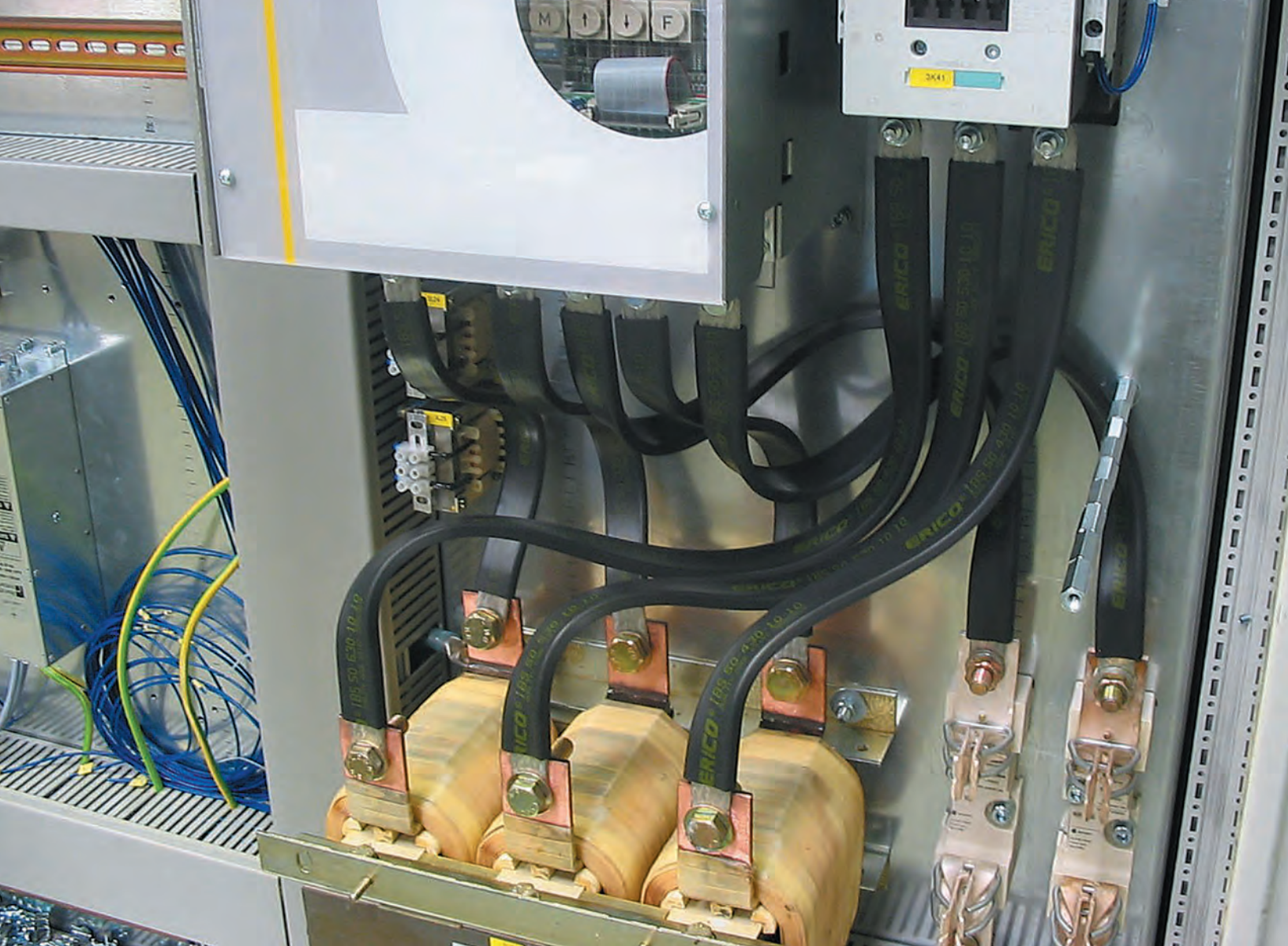

ASSEMBLY INSTRUCTIONS

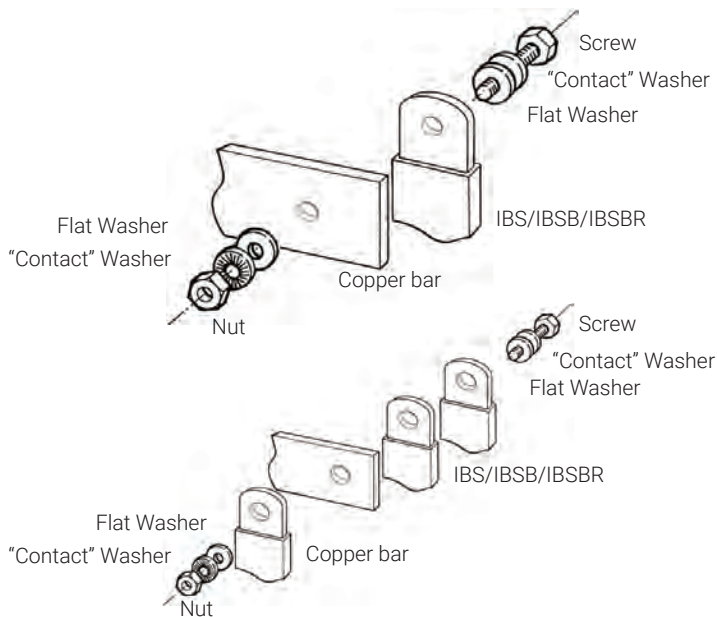

Space between 2 or 3 insulated braided conductors in parallel, for cooling.

A minimum air gap is required. Use FS type spacer clamp.

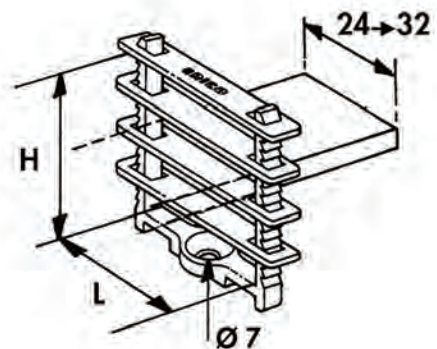

Designation	Part No.	For insulated braided conductor type
FS 24	553550	IBS 25 / 50 IBSB 25 / 50 / 70 / 100
FS 32	553560	IBSBR 120 / 185 / 240

Earth/Ground Copper Braids (MBJ & BJ)

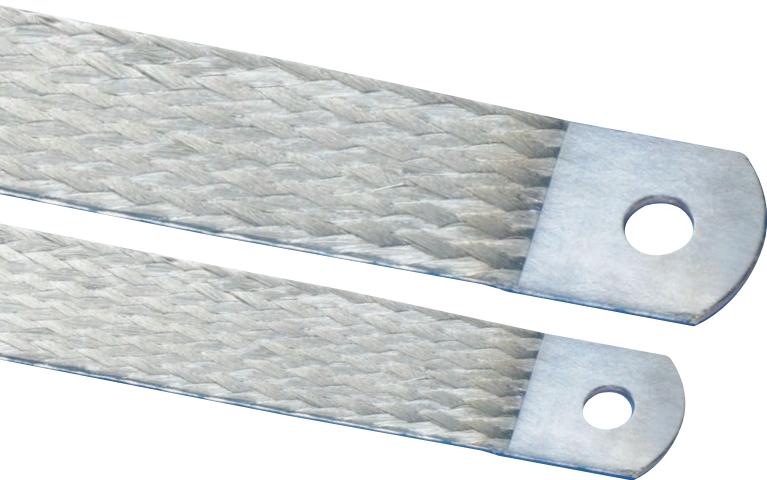

INNOVATIVE, STATE-OF-THE-ART MANUFACTURING PROCESS.

nVent ERIFLEX manufacturing directly the palms of the MBJ tinned-plated braids. This manufacturing process provides an effective electrical contact, due to the integral palms, without the addition of tin or crimped lugs.

This process welds the flexible braid and brings back a solid tinned or red copper block as a palm. Unlike the traditional press-welded palms process. nVent ERIFLEX's process is suitable for red copper, but also for tin plated copper. The electrical contact between each wire is optimized.

This nVent ERIFLEX process also helps eliminate moisture issues in the palms. By using crimped lugs in a severe environment, moisture can enter in the lug (often by capillarity) and create corrosion between each wire. After several years, the electrical contact between each wire can deteriorate and alter the electrical conductivity of the equipment. The corrosion in the palm is impossible to remove without changing the element.

This process produces RoHS products; no additional substances are added to the tinned-plated wires during the manufacturing process.

TINNED COPPER EARTH/GROUND BRAIDS TECHNICAL FEATURES

WITH INTEGRAL PALM



- A complete range of earth/ground flexible connections from 6 to 100 mm² section and from 100 to 500 mm length
- Strong resistance to vibration and fatigue
- Reliable: No extra contact due to the lugs crimped at the ends of the cable
- Weight savings: A flat braid weighs less than a cable (with insulation) and lugs and offers better copper usage (skin effect)
- Integral palm, without tin or crimped lugs for superior electrical contact and tensile strength resistance
- Quick and easy to install: Ready to use, No cutting, stripping, crimping or punching. Less labor time for installation
- Material savings: no lugs or terminals
- Recommended by the EMC/EMI directives and less impedance than cables





BJ

Round braids with crimped lugs



Part No.	Description	Section mm	L mm	Ø D mm	Intensity A		 Kg
556900	BJ 6-150 S	6	150	6.5	45	10	0.010
556910	BJ 6-200 S	6	200	6.5	45	10	0.015
556920	BJ 10-300 S	10	300	6.5	75	10	0.033

EARTH/GROUND COPPER BRAIDS (MBJ & BJ) TECHNICAL CHARACTERISTICS

Part Number	Description	Intensity A	Thickness mm	Section mm ²	L mm	Ø mm	J mm	T mm			Kg
556600	MBJ 6-150-6	40	1.1	6	150	6.5	11	18	10	0.01	
563410	MBJ 6-200-6	40	1.1	6	200	6.5	11	18	10	0.0167	
556930	MBJ 10-200-6	75	1.1	10	200	6.5	11	18	10	0.022	
556610	MBJ 10-300-6	75	1.1	10	300	6.5	11	18	10	0.033	
563540	MBJ 16-100-6	120	1.5	16	100	6.5	15	20	10	0.018	
556620	MBJ 16-100-8	120	1.5	16	100	8.5	15	20	10	0.018	
563550	MBJ 16-150-6	120	1.5	16	150	6.5	15	20	10	0.035	
556630	MBJ 16-150-8	120	1.5	16	150	8.5	15	20	10	0.035	
563300	MBJ 16-200-6	120	1.5	16	200	6.5	15	20	10	0.033	
556640	MBJ 16-200-8	120	1.5	16	200	8.5	15	20	10	0.033	
556650	MBJ 16-250-8	120	1.5	16	250	8.5	15	20	10	0.04	
563320	MBJ 16-300-6	120	1.5	16	300	6.5	15	20	10	0.05	
556660	MBJ 16-300-8	120	1.5	16	300	8.5	15	20	10	0.05	
556940	MBJ 16-500-8	120	1.5	16	500	8.5	15	20	10	0.082	
556670	MBJ 25-100-10	150	1.5	25	100	10.5	22	28	10	0.027	
556680	MBJ 25-150-10	150	1.5	25	150	10.5	22	28	10	0.039	
563340	MBJ 25-200-6	150	1.5	25	200	6.5	22	28	10	0.052	
556690	MBJ 25-200-10	150	1.5	25	200	10.5	22	28	10	0.052	
563430	MBJ 25-200-12	150	1.5	25	200	12.5	22	28	10	0.052	
556700	MBJ 25-250-10	150	1.5	25	250	10.5	22	28	10	0.064	
556710	MBJ 25-300-10	150	1.5	25	300	10.5	22	28	10	0.077	
556950	MBJ 25-500-10	150	1.5	25	500	10.5	22	28	10	0.13	
556720	MBJ 30-100-10	180	2	30	100	10.5	22	28	10	0.032	
556730	MBJ 30-150-10	180	2	30	150	10.5	22	28	10	0.047	
556740	MBJ 30-200-10	180	2	30	200	10.5	22	28	10	0.062	
556750	MBJ 30-250-10	180	2	30	250	10.5	22	28	10	0.075	
556760	MBJ 30-300-10	180	2	30	300	10.5	22	28	10	0.092	
556960	MBJ 30-500-10	180	2	30	500	10.5	22	28	10	0.155	
556770	MBJ 35-100-10	197	2.1	35	100	10.5	22	28	10	0.037	
556780	MBJ 35-150-10	197	2.1	35	150	10.5	22	28	10	0.054	
556790	MBJ 35-200-10	197	2.1	35	200	10.5	22	28	10	0.072	
556800	MBJ 35-250-10	197	2.1	35	250	10.5	22	28	10	0.089	
565000	MBJ 35-250-25	197	1.5	35	250	25.5	40	45	10	0.089	
556810	MBJ 35-300-10	197	2.1	35	300	10.5	22	28	10	0.11	
556970	MBJ 35-500-10	197	2.1	35	500	10.5	22	28	10	0.18	
556820	MBJ 50-100-10	250	2.5	50	100	10.5	28	33	10	0.052	
556830	MBJ 50-150-10	250	2.5	50	150	10.5	28	33	10	0.077	
563350	MBJ 50-200-6	250	2.5	50	200	6.5	28	33	10	0.12	
556840	MBJ 50-200-10	250	2.5	50	200	10.5	28	33	10	0.12	
563440	MBJ 50-200-12	250	2.5	50	200	12.5	28	33	10	0.12	
563360	MBJ 50-200-16	250	2.5	50	200	16.5	28	33	10	0.11	
563370	MBJ 50-200-18	250	2.5	50	200	18.5	28	33	10	0.11	
556850	MBJ 50-250-10	250	2.5	50	250	10.5	28	33	10	0.127	
563380	MBJ 50-300-6	250	2.5	50	300	6.5	28	33	10	0.15	
556860	MBJ 50-300-10	250	2.5	50	300	10.5	28	33	10	0.153	
563390	MBJ 50-300-16	250	2.5	50	300	16.5	28	33	10	0.15	
563400	MBJ 50-300-18	250	2.5	50	300	18.5	28	33	10	0.14	
556980	MBJ 50-500-10	250	2.5	50	500	10.5	28	33	10	0.255	
563560	MBJ 50-500-12	250	2.5	50	500	12.5	28	33	10	0.255	
563450	MBJ 70-300-6	290	3.4	70	300	6.5	28	33	10	0.21	
563460	MBJ 70-300-10	290	3.4	70	300	10.5	28	33	10	0.21	
563420	MBJ 70-300-12	290	3.4	70	300	12.5	28	33	10	0.21	
563470	MBJ 70-300-16	290	3.4	70	300	16.5	28	33	10	0.2	
563480	MBJ 70-300-22	290	2.8	70	300	22.5	40	45	10	0.2	
563490	MBJ 70-500-10	290	3.4	70	500	10.5	28	33	10	0.34	
563500	MBJ 100-250-16	349	4	100	250	16.5	50	55	10	0.254	
563510	MBJ 100-250-30	349	4	100	250	30.5	50	55	10	0.254	
563520	MBJ 100-500-16	349	4	100	500	16.5	50	55	10	0.508	
563530	MBJ 100-500-30	349	4	100	500	30.5	50	55	10	0.508	

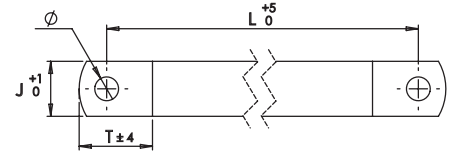
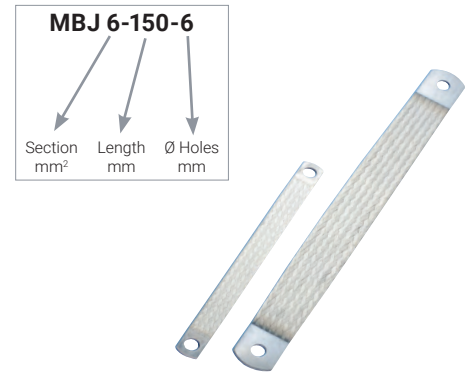

TECHNICAL DATA

- Recommended by EMC/EMI directives
- Flat tinned copper braids
- Electrolytic copper Cu-ETP according to standard EN13602
- Copper purity of minimum 99.9%
- Maximum resistivity of 0.017241 mm²/m at 20°C
- Standard wire diameter; 0.15 mm
- Bends very close to the contact area
- Working temperature up to + 105°C

CERTIFICATION & APPROVALS

- UL Listed (UL467) except BJ
- EAC certificate
- RoHS 2002/95/EC Compliant
- IEC 60439-1 & 61439-1

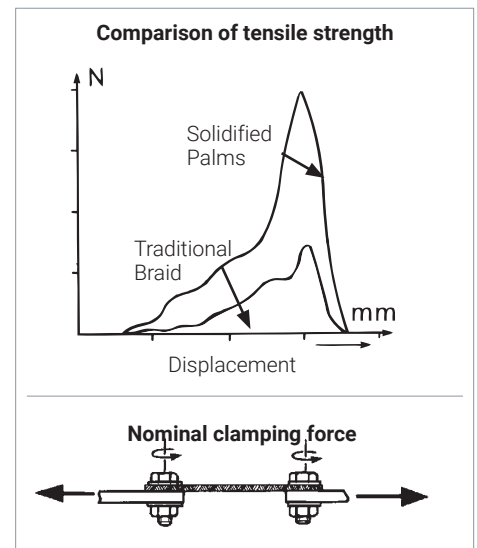

Earth/Ground Stainless Steel Braids (CPI & CPIW)



READY-TO-USE STAINLESS STEEL BRAIDS FOR MULTIPLE APPLICATIONS

nVent ERIFLEX develops and manufactures a range of earth/ground stainless steel braids. These high-quality 316L stainless steel braids can be installed in extremely corrosive environments, like offshore applications or coastal applications. The CPI braid is ideal for applications using stainless steel pipe or tanks, like the food and beverage industry, building industry, transportation, oil and chemical industry.

nVent ERIFLEX offers 316L stainless steel, one of the highest resistant stainless steel options on the market. nVent ERIFLEX has mastered the process of manufacturing stainless steel for braiding, crimping, cutting or punching and offers a full range of ready-to-use stainless steel braids.

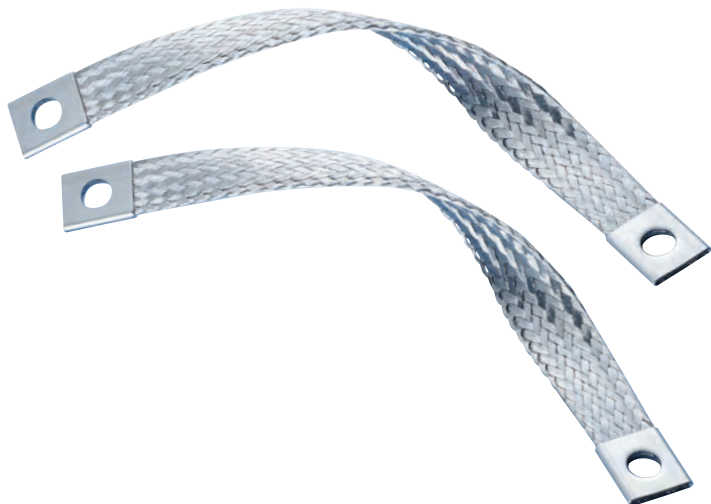

FEATURES

- 316L stainless steel braid ready to use
- Full application range: 16 to 70 mm² section with 150 to 1100 mm length
- High-quality 316L stainless steel: superior abrasion, corrosion, chemical, and UV resistance for outdoor applications
- Good resistance to vibration and fatigue
- Time savings: quick and easy to install. Ready to use. No additional cutting, stripping, crimping and punching needed. Less labor time for installation
- Material savings: No additional lugs or terminals needed
- Durable in outdoor, salt and corrosive environments
- Non-magnetic material
- Long maintenance cycle
- Superior abrasion, corrosion, chemical and UV resistance make it ideal for outdoor applications
- Great for expansion joints where constant movement requires a flexible and indestructible covering
- Won't rust or discolor, so the appearance will never fade or change
- No additional cutting, stripping, or crimping needed
- More flexible connection
- Pre-punched: ready to use
- Excellent electrical contact
- Strong resistance to vibration and fatigue
- Recommended by the EMC directives
- Reduced maintenance

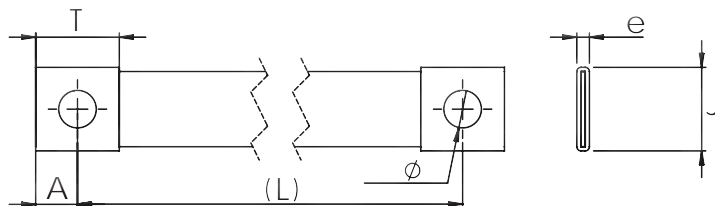

EARTH/GROUND STAINLESS STEEL BRAIDS CPI TECHNICAL CHARACTERISTICS

WHERE STAINLESS BRAIDS CAN BE USED:

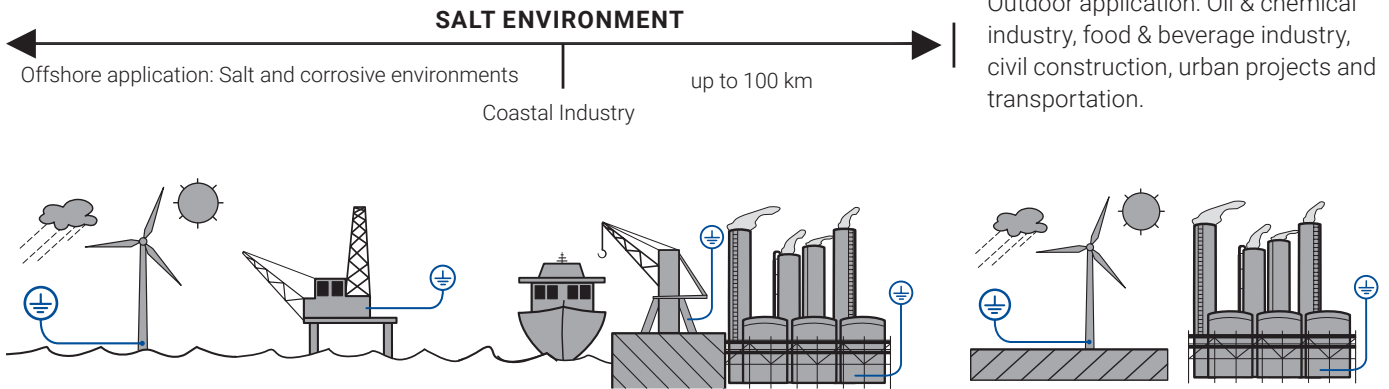

TECHNICAL DATA



- Excellent electrical contact
- Good tensile strength
- Working temperature up to 105°C

BRAID

- 316L Stainless steel
- Wire diameter: 0.25 mm for maximum flexibility
- Strong resistance to vibration

CERTIFICATIONS & APPROVALS

- UL Listed UL467 - grounding and bonding equipment for US and Canada
- RoHS Compliant
- IEC 60439-1 & 61439-1
- ABS American Bureau of Shipping Certificate No. 13-HS1018106-1-PDA-DUP

Part Number	Description	Section mm ²	L mm	Ø mm	J mm	A mm	T mm	e mm		 Kg
554277	CPI 16-150-8	16	150	8.5	17.5	10	20	3	10	0.031
554278	CPI 16-200-8	16	200	8.5	17.5	10	20	3	10	0.037
554279	CPI 16-250-8	16	250	8.5	17.5	10	20	3	10	0.043
554280	CPI 16-300-8	16	300	8.5	17.5	10	20	3	10	0.050
554282	CPI 16-400-8	16	400	8.5	17.5	10	20	3	10	0.062
554286	CPI 16-600-8	16	600	8.5	17.5	10	20	3	10	0.087
554299	CPI 25-150-10	25	150	10.5	26.5	15	30	3.5	10	0.058
554300	CPI 25-200-10	25	200	10.5	26.5	15	30	3.5	10	0.068
554301	CPI 25-250-10	25	250	10.5	26.5	15	30	3.5	10	0.078
554302	CPI 25-300-10	25	300	10.5	26.5	15	30	3.5	10	0.088
554304	CPI 25-400-10	25	400	10.5	26.5	15	30	3.5	10	0.108
554308	CPI 25-600-10	25	600	10.5	26.5	15	30	3.5	10	0.147
554321	CPI 35-150-12	35	150	13	26.5	15	30	4	10	0.071
554322	CPI 35-200-12	35	200	13	26.5	15	30	4	10	0.085
554323	CPI 35-250-12	35	250	13	26.5	15	30	4	10	0.099
554324	CPI 35-300-12	35	300	13	26.5	15	30	4	10	0.112
554326	CPI 35-400-12	35	400	13	26.5	15	30	4	10	0.140
554330	CPI 35-600-12	35	600	13	26.5	15	30	4	10	0.195
554343	CPI 50-150-12	50	150	13	30	15	30	5	10	0.111
554344	CPI 50-200-12	50	200	13	30	15	30	5	10	0.130
554345	CPI 50-250-12	50	250	13	30	15	30	5	10	0.150
554346	CPI 50-300-12	50	300	13	30	15	30	5	10	0.170
554348	CPI 50-400-12	50	400	13	30	15	30	5	10	0.209
554352	CPI 50-600-12	50	600	13	30	15	30	5	10	0.288
554365	CPI 70-150-12	70	150	13	30	15	30	5.8	10	0.139
554366	CPI 70-200-12	70	200	13	30	15	30	5.8	10	0.167
554367	CPI 70-250-12	70	250	13	30	15	30	5.8	10	0.194
554368	CPI 70-300-12	70	300	13	30	15	30	5.8	10	0.222
554370	CPI 70-400-12	70	400	13	30	15	30	5.8	10	0.277
554374	CPI 70-600-12	70	600	13	30	15	30	5.8	10	0.388
554378	CPI 70-800-12	70	800	13	30	15	30	5.8	10	0.498
554384	CPI 70-1100-12	70	1100	13	30	15	30	5.8	10	0.664

CPIW Grounding and Bonding Braid, Stainless Steel for Large Bolts



High-quality CPIW stainless steel grounding and bonding braids can be installed in corrosive environments like offshore applications or coastal applications. The full range of CPIW braids are ideal for applications using stainless steel pipe or tanks, like the food and beverage industry, building industry, transportation or oil and chemical industry.

nVent ERIFLEX offers 316L stainless steel braids, one of the highest resistant stainless steel options on the market. Our proprietary manufacturing process has been optimized to provide the best braiding, welding and connection palm.



FEATURES

- Superior abrasion, corrosion, chemical and UV resistance make CPIW braids ideal for outdoor applications
- Covering from M20 (3/4"-10) up to M42 (1 1/2"-6) bolt fixation point
- Great for expansion joints where constant movement requires a flexible and durable solution
- Ready to use out of the box, eliminates the need for cutting, stripping, crimping and punching
- Quick and easy to install
- Resistant to vibration and fatigue. reducing maintenance
- Will not rust or discolor, so the appearance will never fade or change
- Excellent electrical contact
- No additional lugs or terminals needed
- Non-magnetic material
- Recommended by the EMC/EMI directives
- Performs to the class C5 (very high) category as per ISO 12944-2
- EAC compliant
- RoHS compliant

CPIW GROUNDING AND BONDING BRAID SPECIFICATIONS

- Material: Stainless Steel 316L (EN 1.4404)
- Certification details: UL 467
- Complies with: IEC 60439-1; IEC 61439-1

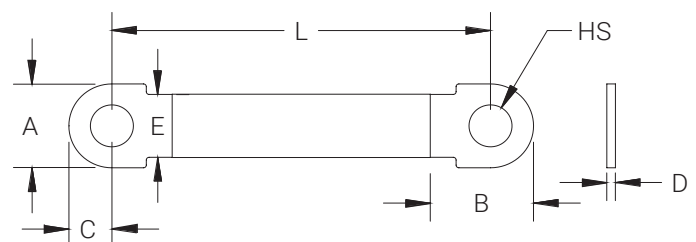

CPIW GROUNDING AND BONDING BRAID, TECHNICAL CHARACTERISTICS



Part No.	Article No.	Cross Section (mm ²)	L (mm)	HS (mm)	A (mm)	B (mm)	C (mm)	D (mm)	E (mm)	Unit Weight (kg)	Minimum Order Quantity
CPIW50-200-20B	554386B	50	200	21	42	51	21	3	30	0.128	50
CPIW50-200-24B	554401B	50	200	25	52	62	26	3	30	0.154	50
CPIW50-250-20B	554398B	50	250	21	42	51	21	3	30	0.148	50
CPIW50-250-24B	554403B	50	250	25	52	62	26	3	30	0.176	50
CPIW50-250-27B	554405B	50	250	28	58	69	29	3	30	0.195	50
CPIW50-250-30B	554407B	50	250	31	62	74	31	3	30	0.207	50
CPIW50-300-20B	554427B	50	300	21	42	51	21	3	30	0.200	50
CPIW50-300-24B	554428B	50	300	25	52	62	26	3	30	0.210	50
CPIW50-300-27B	554429B	50	300	28	58	69	29	3	30	0.220	50
CPIW50-300-30B	554409B	50	300	31	62	74	31	3	30	0.229	50
CPIW50-300-33B	554412B	50	300	34	68	78	34	3	30	0.246	50
CPIW50-300-39B	554416B	50	300	40	78	89	39	3	30	0.284	50
CPIW50-300-42B	554421B	50	300	43	82	94	41	3	30	0.301	50
CPIW50-400-33B	554414B	50	400	34	68	78	34	3	30	0.288	50
CPIW50-400-39B	554418B	50	400	40	78	89	39	3	30	0.327	50
CPIW50-400-42B	554423B	50	400	43	82	94	41	3	30	0.344	50
CPIW70-200-20B	554397B	70	200	21	42	51	21	3	30	0.149	50
CPIW70-200-24B	554402B	70	200	25	52	62	26	3	30	0.175	50
CPIW70-250-20B	554399B	70	250	21	42	51	21	3	30	0.178	50
CPIW70-250-24B	554404B	70	250	25	52	62	26	3	30	0.203	50
CPIW70-250-27B	554406B	70	250	28	58	69	29	3	30	0.221	50
CPIW70-250-30B	554408B	70	250	31	62	74	31	3	30	0.233	50
CPIW70-300-30B	554411B	70	300	31	62	74	31	3	30	0.262	50
CPIW70-300-33B	554413B	70	300	34	68	78	34	3	30	0.278	50
CPIW70-300-39B	554417B	70	300	40	78	89	39	3	30	0.315	50
CPIW70-300-42B	554422B	70	300	43	82	94	41	3	30	0.331	50
CPIW70-400-20B	554388B	70	400	21	42	51	21	3	30	0.264	50
CPIW70-400-33B	554415B	70	400	34	68	78	34	3	30	0.336	50
CPIW70-400-39B	554419B	70	400	40	78	89	39	3	30	0.373	50
CPIW70-400-42B	554424B	70	400	43	82	94	41	3	30	0.389	50

Power Shunt (PBC)

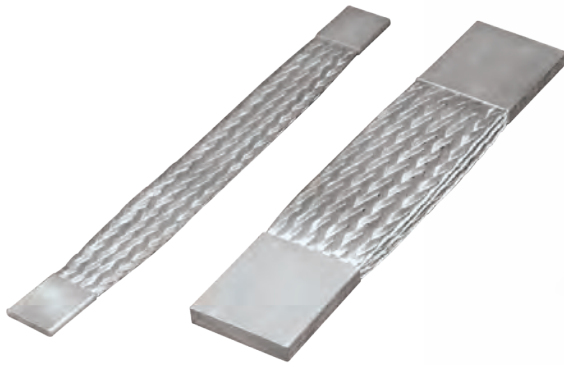

- High flexibility
- Reduce vibrations
- Ideal for transformer-busduct link
- Intensity: Up to 4600 A



PBC BRAIDED POWER SHUNTS

- Undrilled palms to customer's specific designs, fitted by power press
- Extra-flexible power connections (expansion rings, busbar...)
- Tinned electrolytic copper strand 0.15 mm
- When used in parallel, the 2 shunts must be spaced with a minimum distance equal to the thickness of the shunt to allow air cooling

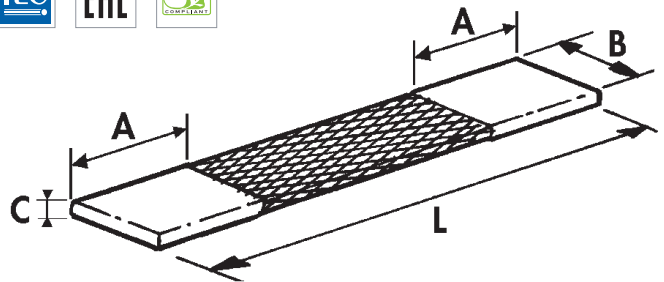

Part No.	Description	Section mm ²	Intensity (ΔT 30K)		Intensity (ΔT 50K)		A mm	B mm	C mm	L mm	Box	Kg
			⏏	⏏	⏏	⏏						
564000	PBC 100 x 250	100	349	600	462	795	35	40	7.0	250	2	0.38
564050	PBC 100 x 500	100	349	600	462	795	35	40	7.0	500	2	0.63
564010	PBC 120 x 250	120	385	670	511	877	35	40	7.5	250	2	0.42
564100	PBC 150 x 250	150	440	757	583	1003	55	50	8.0	250	2	0.63
564150	PBC 150 x 500	150	440	757	583	1003	55	50	8.0	500	2	0.90
564200	PBC 200 x 250	200	550	946	729	1253	55	50	9.0	250	2	0.76
564250	PBC 200 x 500	200	550	946	729	1253	55	50	9.0	500	2	1.20
564300	PBC 250 x 300	250	651	1120	863	1484	85	50	10.5	300	2	1.03
564400	PBC 300 x 400	300	716	1180	948	1565	85	60	11.0	400	1	1.53
564500	PBC 400 x 400	400	853	1360	1131	1808	85	80	11.0	400	1	2.20
564600	PBC 500 x 400	500	917	1561	1216	1944	105	100	11.0	400	1	2.64
564700	PBC 600 x 450	600	1101	1762	1459	2334	105	100	13.0	450	1	3.40
564800	PBC 800 x 450	800	1376	2202	1823	2917	105	100	14.0	450	1	4.26
564900	PBC 1000 x 450	1000	1651	2642	2188	3500	105	100	16.0	450	1	5.47
564030	PBC 1200 x 500	1200	1982	3170	2626	4208	125	120	17.5	500	1	7.16

PPS

Presswelded Power Shunts

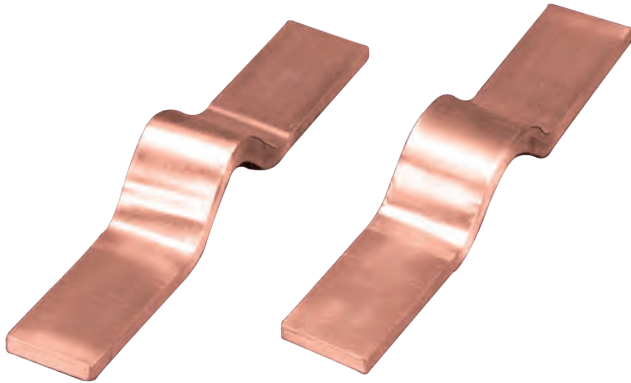

FEATURES

Press welding is welding of laminations to each other through direct current applied to pieces under pressure.

This technique results in:

- The formation of a solid palm with properties of plain bar
- Smaller cross section for same capacity
- Runs cooler than equal section
- Plain copper, thickness of laminates 0.2 mm
- When used in parallel, the 2 shunts must be spaced with a minimum distance equal to the thickness of the shunt

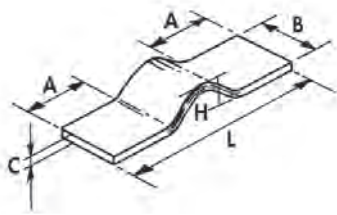

Part No.	Description	Section mm ²	Intensity (ΔT 30K)		Intensity (ΔT 50K)		A mm	B mm	C mm	L mm	H mm	Kg	
			↙	↘	↙	↘							
566030	PPS 50/10/80-280	500	1022	1758	1354	2329	80	50	10	280	58	1	1.440
566040	PPS 80/10/100-320	800	1511	2493	2002	3303	100	80	10	320	52	1	2.625
566050	PPS 100/10/100-300	1000	1825	2920	2418	3869	100	100	10	300	54	1	3.065
566060	PPS 100/10/110-360	1000	1825	2920	2418	3869	110	100	10	360	53	1	3.610
566070	PPS 100/15/110-360	1500	2178	3485	2886	4617	110	100	15	360	57	1	5.385

CUSTOM SOLUTIONS

nVent ERIFLEX can provide made-to-order, custom configurations to your drawing specifications.

nVent ERIFLEX copper braids can be made to custom lengths, widths, thicknesses and hole patterns; with PVC installation, in flat or tubular shapes, using copper wire, in continuous coils, or with soldered studs or crimped lugs. Let nVent ERIFLEX solve your design and production scheduling challenges.



Flat Copper & Stainless Steel Braids (FTCB, FRCB, FSSB & FTFCBI)

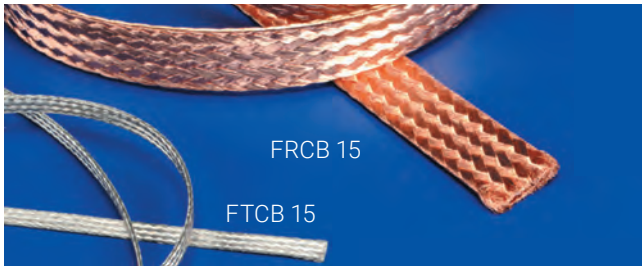

FTCB 15 FLAT TINNED COPPER BRAIDS



- Standard wire diameter: 0.15 mm
- 25 m coils

Part No.	Description	Section mm ²	mm	Number of Wire	Nominal Current A		
557200	FTCB 15-3	3	5x1	168	30	25 m	0.03
557210	FTCB 15-5	5	8x1	288	45	25 m	0.05
557220	FTCB 15-8	8	8x1.5	456	65	25 m	0.08
557230	FTCB 15-10	10	10x1.5	576	75	25 m	0.10
557240	FTCB 15-16	16	15x1.5	896	120	25 m	0.16
557250	FTCB 15-20	20	20x1.5	1120	140	25 m	0.20
557260	FTCB 15-25	25	23x1.5	1404	150	25 m	0.25
557270	FTCB 15-30	30	23x2.0	1692	180	25 m	0.30
557280	FTCB 15-35	35	23x2.5	1980	200	25 m	0.35
557290	FTCB 15-40	40	25x2.5	2272	220	25 m	0.40
557300	FTCB 15-50	50	28x3	2848	250	25 m	0.50
557310	FTCB 15-60	60	30x3	3392	280	25 m	0.60
557320	FTCB 15-70	70	30x3.5	3968	290	25 m	0.70
557330	FTCB 15-75	75	30x4	4256	300	25 m	0.75
557350	FTCB 15-100	100	40x4	5664	360	25 m	1.00

FRCB 15 FLAT PLAIN COPPER BRAIDS

- Standard wire diameter: 0.15 mm
- 25 m coils

Part No.	Description	Section mm ²	mm	Number of Wire	Nominal Current A		
557010	FRCB 15-5	5	8x1	288	45	25 m	0.05
557030	FRCB 15-10	10	10x1.5	576	75	25 m	0.10
557040	FRCB 15-16	16	15x1.5	896	120	25 m	0.16
557050	FRCB 15-20	20	20x1.5	1120	140	25 m	0.20
557060	FRCB 15-25	25	23x1.5	1404	150	25 m	0.25
557080	FRCB 15-35	35	23x2.5	1980	200	25 m	0.35
557090	FRCB 15-40	40	25x2.5	2272	220	25 m	0.40
557100	FRCB 15-50	50	28x3	2848	250	25 m	0.50
557120	FRCB 15-70	70	30x3.5	3968	290	25 m	0.70
557130	FRCB 15-75	75	30x4	4256	300	25 m	0.75
557150	FRCB 15-100	100	40x4	5664	360	25 m	1.00

FTFCBI INSULATED FLAT TINNED COPPER BRAIDS

- Insulation in clear PVC, thickness 1 mm, self-extinguishing UL 94 VO
- Standard wire diameter: 0.15 mm
- 25 m coils
- Insulation voltage: 450 V
- Working temperature: up to 70°C

Part No.	Description	Section mm ²	mm	Number of Wire	Nominal Current A		
510300	FTFCBI 16	16	17x3.5	896	120	25 m	0.18
510310	FTFCBI 25	25	25x3.5	1404	150	25 m	0.29
510340	FTFCBI 50	50	30x5	2848	250	25 m	0.60

FTCB 20 FLAT TINNED COPPER BRAIDS



- Standard wire diameter: 0.20 mm
- Extra long reels

Part No.	Description	Section mm ²	mm	Number of Wire	Nominal Current A		
503510	FTCB 20-5	5	8x1	168	45	500 m	0.05
503520	FTCB 20-10	10	10x1.5	312	75	150 m	0.10
503530	FTCB 20-16	16	15x2	512	120	150 m	0.16
503540	FTCB 20-25	25	25x1.5	792	150	100 m	0.25

FSSB 25 STAINLESS STEEL FLAT BRAIDS



- Standard wire diameter: 0.25 mm
- Stainless steel 316L

Part No.	Description	Section mm ²	mm		
557160	FSSB 25-16 ²	16	15x1.5	25 m	0.14
557170	FSSB 25-25 ²	25	23x1.5	25 m	0.22
557390	FSSB 25-50 ²	50	30x3	25 m	0.44

Round & Tubular Copper Braids (RTCB, RRCT, TTCE)

- A large range of braids
- Bare or insulated

- Tubulars for shielding
- Stainless steel for corrosive environment



RTCB/RTCB HL TINNED COPPER ROUND BRAIDS



RRCB PLAIN COPPER ROUND BRAIDS

Part No.	Description	Section mm ²	External dia in mm	Number of Wire	Nominal Current A			Kg
557600	RTCB 15-6	6	4	352	45	25 m		0.06
557610	RTCB 15-8	8	4.5	464	65	25 m		0.08
557620	RTCB 15-10	10	5	560	75	25 m		0.10
557630	RTCB 15-16	16	6	900	120	25 m		0.16
557640	RTCB 15-25	25	8	1416	150	25 m		0.25
557650	RTCB 15-30	30	9	1680	180	25 m		0.30
557660	RTCB 15-50	50	11	2820	250	25 m		0.50
557670	RTCB 15-75	75	13.5	4236	300	25 m		0.75
557680	RTCB 15-100	100	17	5652	360	25 m		1.00

- Standard wire diameter: 0.15 mm
- 25 m coils

Part No.	Description	Section mm ²	External dia in mm	Number of Wire	Nominal Current A			Kg
557400	RRCB 15-6	6	4	352	45	25 m		0.06
557420	RRCB 15-10	10	5	560	75	25 m		0.10
557430	RRCB 15-16	16	6	900	120	25 m		0.16
557440	RRCB 15-25	25	8	1416	150	25 m		0.25
557450	RRCB 15-30	30	9	1680	180	25 m		0.30
557460	RRCB 15-50	50	11	2820	250	25 m		0.50
557470	RRCB 15-75	75	14	4236	300	25 m		0.75
557480	RRCB 15-100	100	18	5652	360	25 m		1.00

Standard wire diameter 0.15 mm - Extra long reels

503700	RTCB 15-10/HL	10	5	560	75	100 m		0.100
503710	RTCB 15-16/HL	16	6	900	120	100 m		0.160
503720	RTCB 15-25/HL	25	7.5	1416	150	100 m		0.250



TTCE TINNED COPPER TUBULAR BRAIDS

- For screening connecting cables between equipment used in an electromagnetically disturbed environment.
- Supplied with draw wire

Part No.	Description	Section mm ²	Diameter (mm)				Number of Wire	Ø wires mm	Nominal Current A			Kg
			Int.	Covering %	Exp.	Covering %						
510100	TTCE 3	1.7	3	100%	6	90%	96	0.15	13	50 m		0.020
510110	TTCE 5	2.5	5	99%	10	92%	144	0.15	19	50 m		0.026
510120	TTCE 8	4.45	8	99%	16	95%	252	0.15	37	50 m		0.050
510130	TTCE 10	5.7	10	100%	20	92%	320	0.15	43	50 m		0.054
510140	TTCE 15	12	15	100%	30	94%	334	0.15	90	50 m		0.120
510150	TTCE 20	20.4	20	99%	40	87%	288	0.30	122	50 m		0.190
510160	TTCE 25	27.1	25	99%	50	92%	384	0.30	163	25 m		0.270
510170	TTCE 30	33.9	30	100%	60	90%	480	0.30	185	25 m		0.320
510180	TTCE 35	40.7	35	100%	70	94%	576	0.30	244	25 m		0.380

Extra long reels

504690	TTCE 8/HL	6.8	8	-	16	-	216	0.15	37	200 m		0.050
--------	-----------	-----	---	---	----	---	-----	------	----	-------	--	-------

The primary use of tubular braid is to provide sensitive cables with an EMC/EMI screen to shield them against electromagnetic, electrostatic and radio frequency interference. Optimum screening performance is obtained using copper wire braid that can also be used for earth continuity purposes.

Round Copper Braids (RRCBI & RTCBI)





RRCBI INSULATED PLAIN COPPER ROUND BRAIDS



- Insulation in clear PVC, thickness 1 mm, self-extinguishing UL 94 - VO
- Standard wire diameter: 0.15 mm
- Insulation voltage: 450 V
- Working temperature: up to 70°C



RTCBI / RTCBI HL INSULATED ROUND TINNED COPPER BRAIDS

- Insulation in clear PVC, thickness 1 mm, self-extinguishing UL 94 - VO
- Standard wire diameter: 0.15 mm
- 25 m coils
- Insulation voltage: 450 V
- Working temperature: up to 70°C

Part No.	Description	Section mm ²	External dia in mm	Number of Wire	Nominal Current A		 Kg
510500	RRCBI 15-10	10	7	560	75	25 m	0.10
510510	RRCBI 15-16	16	8	900	120	25 m	0.16

Part No.	Description	Section mm ²	External dia in mm	Number of Wire	Nominal Current A		 Kg
503400	RTCBI 15-10	10	7	560	75	25 m	0.12
503410	RTCBI 15-16	16	8	900	120	25 m	0.18
503420	RTCBI 15-25	25	9.5	1416	150	25 m	0.25
503430	RTCBI 15-30	30	10	1680	180	25 m	0.35
503440	RTCBI 15-50	50	12.5	2820	250	25 m	0.58

On Request Special Manufacturing:

- Tubular braids up to 60 mm diameter maximum
- Flat or round copper braids up to 400 mm² maximum
- Insulation 105° C



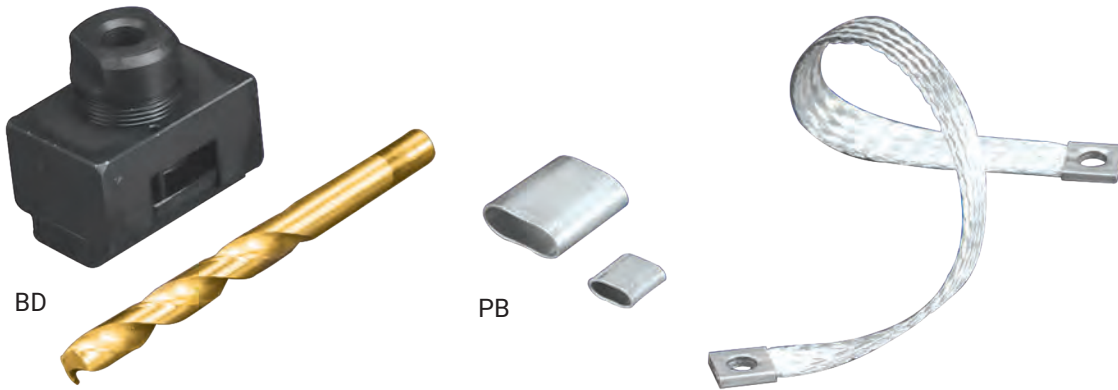

Make Your Own Braided Connections



BD CRIMP AND DRILL TOOL

- This tool has been developed by nVent ERIFLEX specifically for crimping and drilling of braid terminals. Guide and specially adapted drill bit included

Part No.	Description	For Flat	Ø Drill Bit	Bolt	 Kg	
558610	BD 16	FTCB or FRCB 15-16	6.5	M6	1	0.653
558640	BD 16-8.5	FTCB or FRCB 15-16	8.5	M8	1	0.653
558620	BD 25	FTCB or FRCB 15-25	11	M10	1	0.678
558630	BD 50	FTCB or FRCB 15-50	12.5	M126	1	0.712

HCT 3-4 CRIMPING TOOL FOR HYDRAULIC WORK CENTER



- This package allows to crimp lugs PB16, PB25 and PB50 on braids with the hydraulic nVent ERIFLEX Puncher

Part No.	Description		
545980	HCT 3-4	1	1.850

PB LUGS FOR FLAT BRAIDS (FTCB OR FCRB)

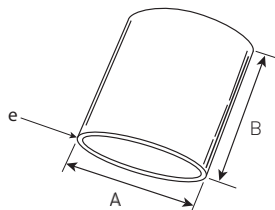
- In tinned annealed copper



Part No.	Description	For Flat	A	B	e		
557180	PB 16	FTCB or FRCB 15-16	16	15	1	100	0.004
557190	PB 25	FTCB or FRCB 15-25	22	25	1	100	0.010
557380	PB 50	FTCB or FRCB 15-50	30	30	1	100	0.017

ABOUT ELECTROMAGNETIC COMPATIBILITY

In an environment where electromagnetic disturbances are more and more numerous, the ElectroMagnetic Compatibility (EMC) is increasingly important in the design and building of electrical panels.

In order to avoid stray currents, it is necessary that all the metallic framework, inside the panel or outside, is at the same electrical potential. Thus, it is essential to link all these metal parts with connections presenting a low impedance at High Frequency (H.F.).

Connections with cables are not efficient. Only short and flat conductors are. Their H.F. impedances are 10 times lower than the wire impedances.

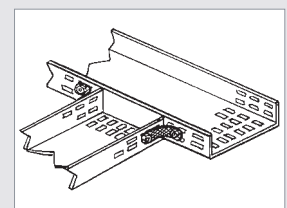
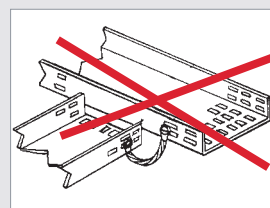
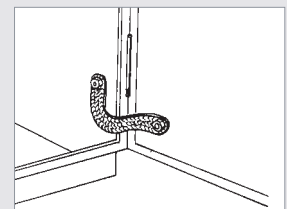
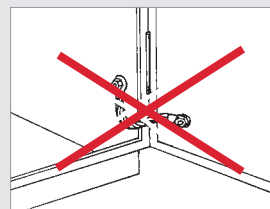

Made to Order Solutions (MTO)

FLEXIBAR CUSTOM SOLUTIONS (MADE TO ORDER)

nVent ERIFLEX can provide preformed Flexibar configurations to your drawing specifications. Flexibar can be cut, punched, twisted or bent to address your most challenging panelboard designs and production scheduling requirements. Give nVent ERIFLEX your low voltage connection challenges!

BRAIDED CONDUCTORS CUSTOM SOLUTIONS (MADE TO ORDER)

nVent ERIFLEX brand of copper braids can be made to custom lengths, widths, thicknesses and hole patterns, with PVC or Advanced Technology insulation, in flat or tubular shapes, using copper or stainless steel wire, in continuous coils, or with soldered studs or crimped lugs. Let nVent ERIFLEX solve your design and production scheduling challenges.

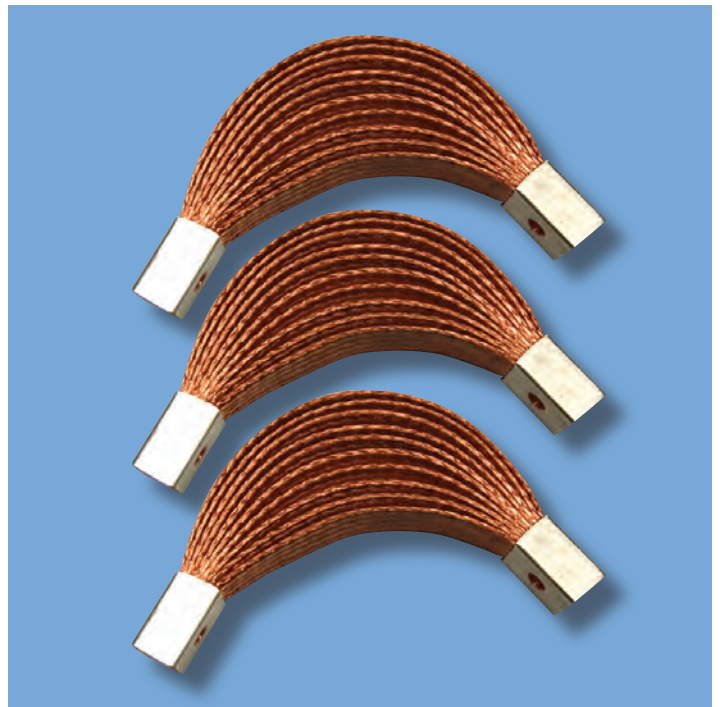
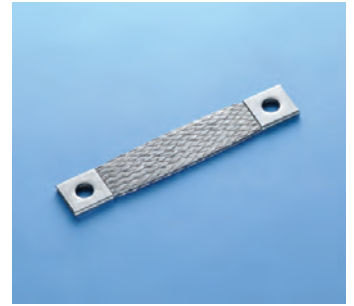

Made to Order Solutions

CUSTOM SOLUTIONS (MADE TO ORDER) - CHECK LIST

Summary of the information we need for custom design work. Please photocopy this page and complete it by providing the information you know and sending to your local nVent ERIFLEX customer service representative. (Sections can be left blank)

Electrical Function:

Earthing/grounding conductor.....
 Power conductor.....
 Nominal current..... A
 Alternating or direct current.....
 Nominal voltage..... V
 Insulation specification (if require).....

Material:

Red/plain copper.....
 Tinned copper.....
 Stainless steel.....
 Aluminum.....
 Other.....

Environment:

Ambient temperature..... C°
 Operating temperature..... C°
 Conductor maximum temperature..... C°
 Humidity (dry/average/moist)..... %HR

EXTREMITY/TERMINAL DIMENSIONS:

Indicate your dimensions on the proposed terminal drawing or make a sketch showing your needs.

Conductor Dimensions:

Availability: Drawing Specification Samples
 Cross Section _____ mm²
 Flat or Round Section _____
 Width of the Conductor _____ mm
 Thickness of the Conductor _____ mm
 Length of the Conductor _____ mm
 Quantity _____

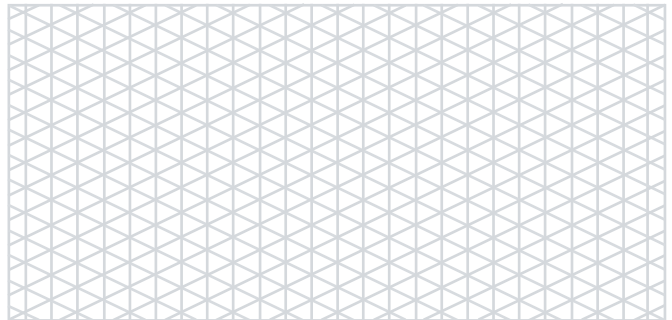

Contact/Requested by:

Company _____
 Contact Name _____
 Phone Number _____

E-mail address _____
 Address (City & Country) _____

Cross Reference List

Part Number	Page	Part Number	Page	Part Number	Page
503400	48	552400	19	552760	19
503410	48	552410	17	552770	17
503420	48	552410	19	552780	17
503430	48	552420	17	552790	17
503440	48	552420	19	552800	17
503500	46	552430	17	552810	17
503510	46	552430	19	552830	17
503520	46	552440	17	552840	17
503530	46	552440	19	552850	17
503540	46	552450	17	552860	17
503620	46	552450	19	552870	17
503700	47	552460	17	552880	19
503710	47	552460	19	552890	17
503720	47	552470	17	552900	17
503730	47	552470	19	552910	17
503820	48	552480	17	552920	17
503830	48	552480	19	552930	17
504690	47	552490	17	552950	17
505501	19	552490	19	552960	17
505502	19	552500	17	552970	17
505503	19	552500	19	552980	17
505506	19	552510	17	552990	17
505507	19	552510	19	553020	24
505508	19	552520	17	553030	24
505514	19	552530	17	553040	24
505515	19	552540	17	553050	24
510100	47	552550	17	553060	24
510110	47	552550	19	553070	24
510120	47	552560	17	553100	24
510130	47	552560	19	553110	24
510140	47	552570	17	553120	24
510150	47	552570	19	553200	24
510160	47	552580	17	553210	24
510170	47	552590	17	553220	24
510180	47	552600	17	553230	24
510300	46	552610	17	553250	24
510310	46	552620	17	553260	24
510340	46	552620	19	553370	23
510500	48	552630	17	553380	23
510510	48	552630	19	553400	25
538650	17	552640	17	553405	25
541060	19	552640	19	553410	25
541090	19	552650	17	553430	25
541100	19	552660	17	553440	25
541110	19	552670	17	553505	25
541150	19	552680	17	553510	25
541160	19	552690	17	553520	25
541170	19	552690	19	553530	25
541230	19	552700	17	553540	25
541240	19	552700	19	553550	23
541774	22	552710	17	553550	37
541775	22	552710	19	553560	23
541776	22	552720	17	553560	37
545980	39	552730	17	553570	23
552390	17	552740	17	553580	23
552390	19	552750	17	553590	23
552400	17	552760	17	554277	41

Cross Reference List

Part Number	Page	Part Number	Page	Part Number	Page
554278	41	556860	39	557660	47
554279	41	556900	38	557670	47
554280	41	556910	38	557680	47
554282	41	556920	38	558240	33
554286	41	556930	39	558241	33
554299	41	556940	39	558242	33
554300	41	556950	39	558243	33
554301	41	556960	39	558244	33
554302	41	556970	39	558249	33
554304	41	556980	39	558250	33
554308	41	557010	46	558255	33
554321	41	557030	46	558256	33
554322	41	557040	46	558260	33
554323	41	557050	46	558261	33
554324	41	557060	46	558262	33
554326	41	557080	46	558263	33
554330	41	557090	46	558264	33
554343	41	557100	46	558270	33
554344	41	557110	46	558271	33
554345	41	557120	46	558272	33
554346	41	557130	46	558273	33
554348	41	557150	46	558274	33
554352	41	557160	46	558276	33
554365	41	557170	46	558280	33
554366	41	557180	49	558281	33
554367	41	557190	49	558282	33
554368	41	557200	46	558283	33
554370	41	557210	46	558284	33
554374	41	557220	46	558285	33
554378	41	557230	46	558290	33
554384	41	557240	46	558291	33
556600	39	557250	46	558292	33
556610	39	557260	46	558293	33
556620	39	557270	46	558294	33
556630	39	557280	46	558295	33
556640	39	557290	46	558500	31
556650	39	557300	46	558501	31
556660	39	557310	46	558502	31
556670	39	557320	46	558503	31
556680	39	557330	46	558504	31
556690	39	557350	46	558505	31
556700	39	557380	49	558506	31
556710	39	557390	46	558507	31
556720	39	557400	47	558508	31
556730	39	557420	47	558509	31
556740	39	557430	47	558510	31
556750	39	557440	47	558511	31
556760	39	557450	47	558512	31
556770	39	557460	47	558513	31
556780	39	557470	47	558514	31
556790	39	557480	47	558515	31
556800	39	557600	47	558516	31
556810	39	557610	47	558517	31
556820	39	557620	47	558518	31
556830	39	557630	47	558519	31
556840	39	557640	47	558520	31
556850	39	557650	47	558521	31

Cross Reference List

Part Number	Page	Part Number	Page	Part Number	Page
558522	31	564000	44	505516*	18
558523	31	564010	44	505517*	18
558524	31	564030	44	505518*	18
558525	31	564050	44	505519*	18
558526	31	564100	44	505523*	18
558527	31	564150	44	505526*	18
558528	31	564200	44	538650*	18
558529	31	564250	44	541180*	18
558530	31	564300	44	541250*	18
558531	31	564400	44	541260*	18
558532	31	564500	44	541270*	18
558533	31	564600	44	541320*	18
558534	31	564700	44	541380*	18
558535	31	564800	44	552520*	18
558536	31	564900	44	552530*	18
558537	31	564960	44	552540*	18
558538	31	564961	44	552580*	18
558539	31	564962	44	552590*	18
558540	31	564963	44	552600*	18
558541	31	564964	44	552610*	18
558542	31	564965	44	552650*	18
558543	31	564966	44	552660*	18
558544	31	564967	44	552670*	18
558545	31	564968	44	552680*	18
558546	31	564969	44	552720*	18
558610	49	564970	44	552730*	18
558620	49	564971	44	552740*	18
558630	49	564972	44	552750*	18
558640	49	565000	39	552770*	18
558880	25	566030	45	552780*	18
561200	25	566040	45	552790*	18
561210	25	566050	45	552800*	18
561220	25	566060	45	552810*	18
563300	39	566070	45	552830*	18
563320	39	566490	21	552840*	18
563340	39	566500	21	552850*	18
563350	39	566510	21	552860*	18
563360	39	566520	21	552870*	18
563370	39	566550	21	552890*	18
563380	39	566560	21	552900*	18
563390	39	566570	21	552910*	18
563400	39	566580	21	552920*	18
563410	39	566590	21	552930*	18
563420	39	566630	21	552950*	18
563430	39	566640	21	552960*	18
563440	39	566650	21	552970*	18
563450	39	566660	21	552980*	18
563460	39	566670	21	552990*	18
563470	39	566720	21	534000	13
563480	39	566730	21	534001	13
563490	39	566750	21	534002	13
563500	39	566780	21	534003	13
563510	39	566800	21	534004	13
563520	39	566810	21	534005	13
563530	39	568700	25	534006	13
563540	39	568730	25	534007	13
563550	39	505509*	18	534008	13
563560	39	505510*	18	534009	13

Cross Reference List

Part Number	Page	Part Number	Page
534010	13	558595	35
534011	13	554386B	43
534012	13	554401B	43
534013*	13	554398B	43
534014*	13	554403B	43
534015*	13	554405B	43
534016	13	554407B	43
534017	13	554427B	43
534018	13	554428B	43
534019*	13	554429B	43
534020*	13	554409B	43
534021*	13	554412B	43
534022*	13	554416B	43
534023	13	554421B	43
534024	13	554414B	43
534025	13	554418B	43
534026*	13	554423B	43
534027*	13	554397B	43
534028*	13	554402B	43
534029*	13	554399B	43
534030	13	554404B	43
534031	13	554406B	43
534032	13	554408B	43
534033*	13	554411B	43
534034*	13	554413B	43
534035*	13	554417B	43
534036*	13	554422B	43
534037	13	554388B	43
534038*	13	554415B	43
534039*	13	554419B	43
534040*	13	554424B	43
534041*	13		
534042*	13		
534044*	13		
534045*	13		
534046*	13		
534047*	13		
534048*	13		
534049*	13		
534050*	13		
534051*	13		
534052*	13		
534053*	13		
534055*	13		
534056*	13		
534057*	13		
534058*	13		
534059*	13		
534060*	13		
558584	35		
558586	35		
558587	35		
558588	35		
558589	35		
558591	35		
558592	35		
558593	35		
558594	35		

Our powerful portfolio of brands:

CADDY ERICO HOFFMAN RAYCHEM SCHROFF TRACER



[nVent.com/ERIFLEX](https://www.nVent.com/ERIFLEX)

WARNING: nVent products shall be installed and used only as indicated in nVent's product instruction sheets and training materials. Instruction sheets are available at [nVent.com/ERIFLEX](https://www.nVent.com/ERIFLEX) and from your nVent customer service representative. Improper installation, misuse, misapplication or other failure to completely follow nVent's instructions and warnings may cause product malfunction, property damage, serious bodily injury and death and/or void your warranty.

©2018 nVent. All nVent marks and logos are owned or licensed by nVent Services GmbH or its affiliates. All other trademarks are the property of their respective owners. nVent reserves the right to change specifications without notice.

ERIFLEX-CAT-P1300C-P476LT17NAEN-EN-1805